

Conservative ultrasonic dentistry

EVERYDAY, FOR EVERY CLINICAL SITUATION

Enhancing your workflows
through innovation

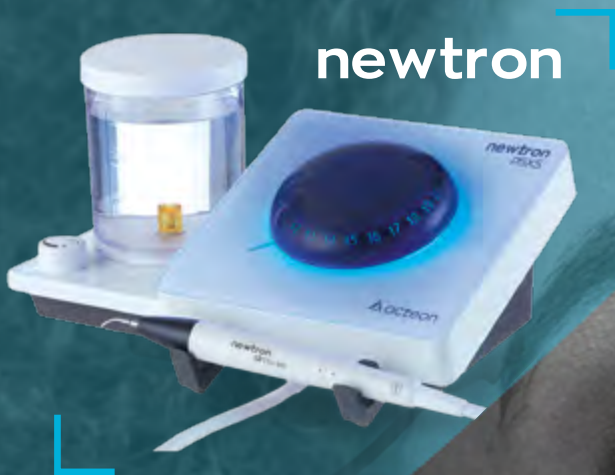

Efficacy and safety with Newtron® technology



Perfect ultrasonic vibrations, combined with high quality tips, preserve teeth and ensure accurate treatments.

- **Precision**

Precise treatments thanks to the controlled linear vibrations

- **Preservation**

Tissue preservation with the automatic and continuous frequency adjustment

- **Comfort**

Comfort for the patient and practitioner thanks to the real time power adjustment

A large range of tips meeting all the clinical needs

The widest range in the market, having over 60 different tips, with exclusive designs, alloys and coatings for clinical versatility.

PROPHYLAXIS



PERIODONTICS



ENDODONTICS



SURGICAL ENDODONTICS



IMPLANT CARE



PROSTHETIC DENTISTRY



“

Procedures are done much quicker, much more effective and again much easier for both hygienist and the patient.

Dr. Kaminer, USA

ACTEON® devices and instruments assist me daily in ensuring a successful outcome to my patients

Dr Gorni, Italy



Gentle treatments thanks to Newtron® technology



- Controlled linear and regular vibrations
- Automatic and continuous frequency adjustment according to each tip shape and weight
- Real time power adjustment



- Total irrigation control
- Powerful cavitation

Enhanced visibility for accurate procedures

- **Optimized external irrigation system**

Thanks to the inner part of the handpiece in titanium, **any type of irrigation solution including water**, sodium hypochlorite and chlorhexidine, can be used.

The 300ml or 500ml graduated tanks allow to mix solutions directly, and to fill in during procedures.



- **Reduced nebulization**
Better visibility

The **irrigation can be reduced and controlled**, allowing better visibility and lowering nebulization.

- **Irrigation to the end of the tip**

The easy and precise flow adjustment provides more powerful cavitation and maximum tip efficiency (deposits fragmentation, disinfecting effect).

- **F.L.A.G.™ for B.LED guides the practitioner for a precise and accurate treatment**

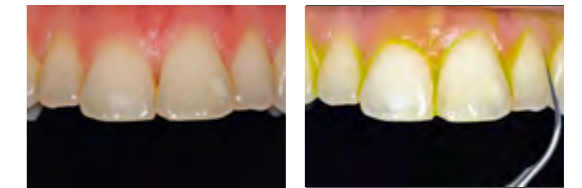

Without B.LED

With B.LED

Applied on teeth, F.L.A.G.™ for B.LED highlights the dental plaques when used under the Newtron® slim B.LED handpiece and guides the practitioner in his procedure.

- **Enhances treatment accuracy** and avoids the overuse of instruments, thus preserving healthy tissues.

- **Enables practitioners to educate patients and to encourage compliance.**



Simple and intuitive settings with the Color Coding System™

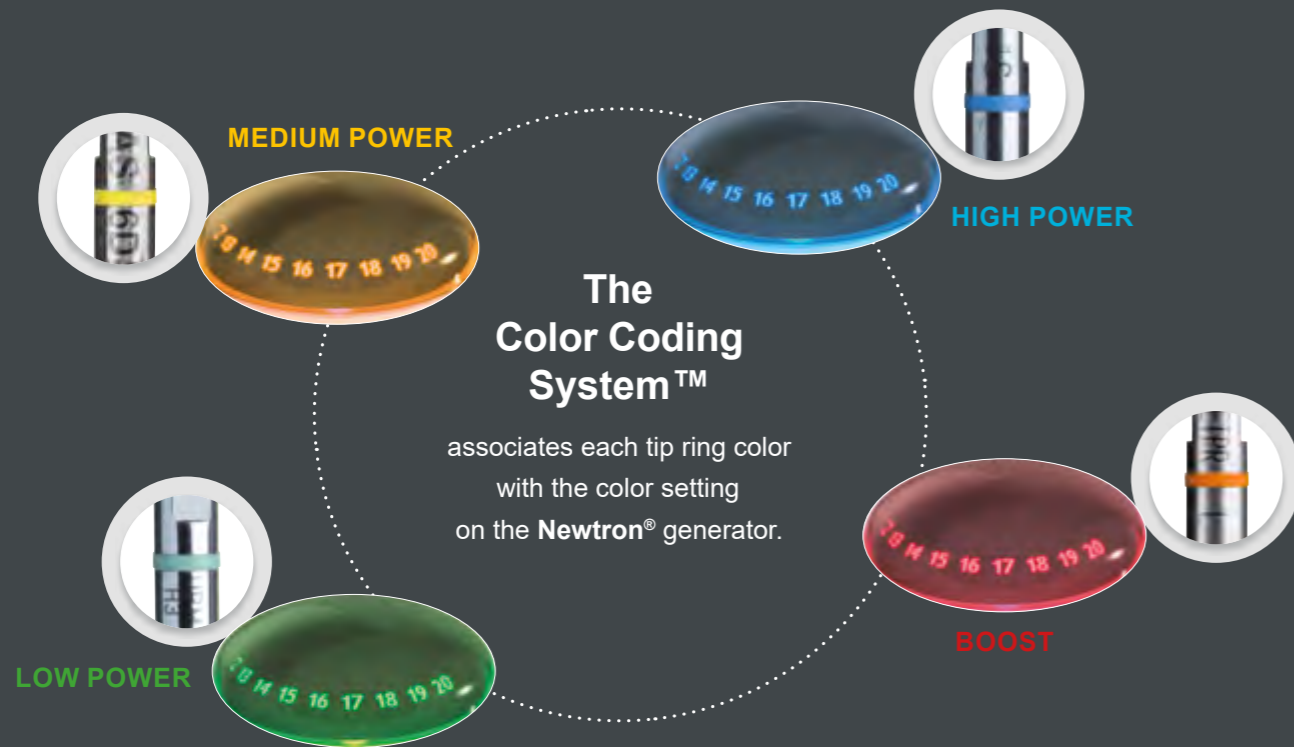

A design adapted to your needs

- Elegant device**
 Flat glass surface, clean line and luminous power dial
- Optimal ergonomics**
 Inclined front panel for better interaction with the practitioner and accessibility to the settings and the handpiece
- Meeting hygiene requirements**
 - Removable power adjustment knob for easy decontamination
 - Total watertightness
- Balanced Newtron® slim handpiece**
 - Ergonomic shape regardless of the grip position, with flexible cord
 - Interior in Titanium for extreme resistance to corrosion
- Exclusive handpiece holders to prevent falls**
 Installed on the front or the side of the device, the holders in silicone can be removed and autoclaved



A large and versatile range of tips interacting in harmony with the handpiece and the device to deliver optimum performance

Newtron® tips are conceived to meet all clinical needs, thanks to exclusive designs, alloys and coatings that respect the surfaces treated: enamel, crown, implant.





scaling

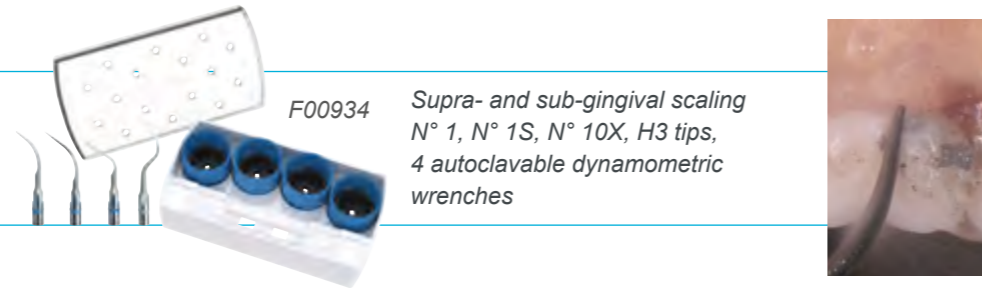

F00934 *Supra- and sub-gingival scaling
N° 1, N° 1S, N° 10X, H3 tips,
4 autoclavable dynamometric
wrenches*



1
F00246

2
F00247



3
F00248

10P
F00253



10Z
F00254

Supra-gingival scaling



1 Universal tip
Simple cases: gross supra-gingival scaling.
Tangential orientation to the surface.
To-and-fro sweeping to "detach" the tartar whilst respecting the enamel.



2 Voluminous calculus
Removal of significant supra-gingival deposits.
Apply the flat part to the tooth surfaces.



3 Stains
Removal of marks and stains (tobacco, tea, coffee, etc.).
Apply the rounded extremity of the tip to the surface to be treated.

Sub-gingival scaling and probing



10P Shallow pockets
Scaling of pockets less than 2-3mm deep.

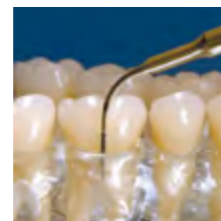

10Z Medium pockets
Scaling of medium pockets (< 4mm).
Removal of biofilm and soft deposits, while evaluating the depth of the pockets using the marks every 3mm.
Efficient for maintenance treatment in patients with good dental hygiene.



hygiene



F00935 *N° 1, N° 1S, N° 10Z, TK1-1S tips,
4 autoclavable dynamometric
wrenches*

Supra- and sub-gingival scaling



1S Slim tip
Interproximal spaces scaling. Finer and longer than tip No.1, it is also powerful and robust.

Supra-gingival scaling and interproximal spaces

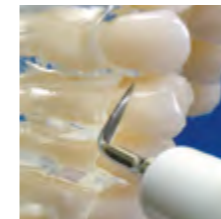

10X Interproximal spaces
Its anatomical shape allow fast and efficient procedure.



1S
F00245

10X
F00359

periofine

Smooth biofilm elimination

PFU Dental plaque and sub-gingival small deposits removal
Oriented tangentially: its shape adapts to the anatomy of the tooth for a painless and easy access.

PFL Interproximal scaling of narrow areas
Left-oriented for an easy access to premolars and molars.

PFR Interproximal scaling of narrow areas
Right-oriented for debridement and cleaning of medium pockets.



PFU
F02170

PFL
F02171



PFR
F02172



periodontics

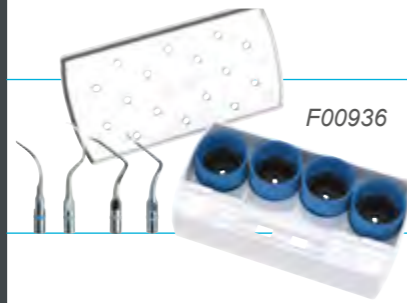

F00936 N° 1S, H3, H4L, H4R tips,
4 autoclavable dynamometric
wrenches

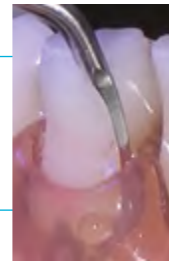

Periodontal debridement

H3
F00369



Initial periodontics, anterior sector

Treatment of the incisor-canine block.

The guide edge is oriented parallel to the pocket. The H3 tip is descended into the periodontal pocket without risk of injury to the ligament. The cavitation will lift the debris out.

H4L
F00114



Periodontics for the premolar and molar sectors, left-oriented

First instrument in the sequence for treating all the surfaces and the furcations.

- Maxillary: buccal and distal surfaces of sector 2, pivots at 13, then the buccal and mesial surfaces of sector 1.
- Mandibular: buccal and distal surfaces of sector 4, pivots at 43, then lingual and mesial surfaces of sector 3.

H4R
F00115



Periodontics for the premolar and molar sectors, right-oriented

Second instrument in the sequence.

- Maxillary: palatine and mesial surfaces of sector 2, pivots at 13, then buccal and distal surfaces of sector 1
- Mandibular: lingual and mesial surfaces of sector 4, pivots at 43, then buccal and distal surfaces of sector 3.



Root planing



Anterior tooth root planing, diamond-coated tip 30 µm

- Diamond-coated mini-tip for simple cases in the cervical area.
- Also effective for the withdrawal of granulation tissue.

This tip should be used without pressure and above the epithelial attachment because it is abrasive.



Root planing of the premolar and molar sectors, left-oriented, diamond-coated tip 30µm

Diamond-coated micro-probe for the treatment of furcations and narrow spaces.



Root planing of the premolar and molar sectors, right-oriented, diamond-coated tip 30µm

Diamond-coated micro-probe for the treatment of furcations and narrow spaces.

H1
F00366



H2L
F00367



H2R
F00368



perio maintenance BDR

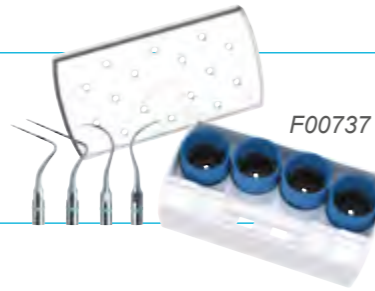

F00737

TK1-1S, TK1-1L, TK2-1L, TK2-1R tips, 4 autoclavable dynamometric wrenches



F00939

P2L, P2R, TK1-1S tips, 3 autoclavable dynamometric wrenches



perio precision

Biofilm disruption



Short probe

Graduated every 3mm, for examining shallow and medium pockets (< 4mm) and for the maintenance of simple cases.



Long probe

Examination and maintenance of medium to deep pockets (> 4mm). Diagnosis aid during the debridement and irrigation of pockets.

The TK1 probe tips are used without pressure following the contour of the pockets and skimming over the root surface.



Maintenance of the premolar and molar sectors, left-oriented

Maintenance of moderate to deep pockets and furcations. Equivalent to the Nabers probe.



Maintenance of the premolar and molar sectors, right-oriented

Complementary to the TK2-1L tip for the maintenance of moderate to deep pockets and furcations. Equivalent to the Nabers probe.

Periodontal maintenance



Debridement of the premolar and molar sectors, left-oriented

Round micro-tip recommended for periodontal debridement in the presence of a fine peridontium and in narrow areas.

- Maxillary: buccal and distal surfaces of sector 2, pivots at 13, then the palatine and mesial surfaces of sector 1.
- Mandibular: buccal and distal surfaces of sector 4, pivots at 43, then lingual and mesial surfaces of sector 3.



Debridement of the premolar and molar sectors, right-oriented

Second instrument in the sequence, after the P2L tip.

The double bend makes it possible to treat areas that are difficult to access (inter-radicular spaces, deep pockets).

- Maxillary: buccal and mesial surfaces of sector 2, pivots at 13, then buccal and distal surfaces of sector 1.
- Mandibular: lingual and mesial surfaces of sector 4, pivots at 43, then buccal and distal surfaces of sector 3.

The P2 tips can also be used to remove small amounts of excess cement when bonding fixed prosthesis.

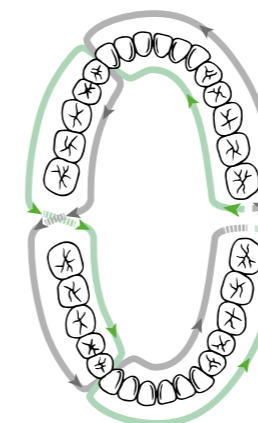

→ TK2-1L / P2L
→ TK2-1R / P2R



TK1-1S
F01001



TK1-1L
F01004



TK2-1L
F02162



TK2-1R
F02161



P2L
F00090



P2R
F00091

periosoft



PH1
F00702



PH2L
F00705



PH2R
F00706

Implant and prosthesis prevention



Hygiene of anterior sector

Plastic micro-tip with universal curette shape for the treatment of the incisor/canine groups.

- Removal of the biofilm and low adherence deposits without scratching the prosthetic surfaces.
- Polishing the sulcus or grooves of natural teeth.



Hygiene of premolar and molar sectors, left-oriented

Plastic micro-tip with 13-14 curette shape for the removal of biofilm and low adherence deposits for the treatment of the posterior groups.

- Maintenance for the screws and abutment of the implant.
- Scaling of prosthesis.

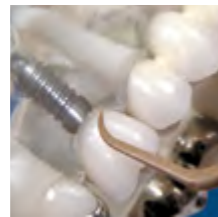

Hygiene of premolar and molar sectors, right-oriented

Plastic micro-tip with 13-14 curette shape for the removal of biofilm and low adherence deposits for the treatment of the posterior groups.

The new material for these tips makes it possible to clean and debride faster, and gives better breakage resistance. Max. Power = 3 (start of green mode).

implantprotect pure titanium

Pure titanium tips to preserve implant surfaces.

F02120



IP1, IP2L, IP2R, IP3L, IP3R tips, autoclavable metal support and universal wrench

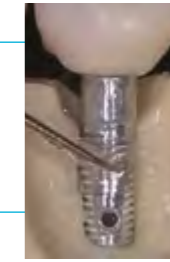

Treatment of peri-implantitis and maintenance



Debridement of the implant abutment and wide threads

Pure titanium tip with a wider extremity for implant abutment cleaning and large thread debridement.

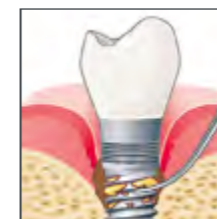

Debridement of medium implant threads, left-oriented

Pure titanium tip with a similar shape to P2L tip for the debridement of medium implant threads. The bend of the tip allows movement around the entire implant for total decontamination.



Debridement of medium implant threads, right-oriented

Pure titanium tip with a similar shape to P2R for the debridement of medium-sized implant threads. The approach may be non-surgical or open flap.



Debridement of narrow implant threads, left-oriented

Pure titanium tip with a pointed extremity suitable to reach narrow implant threads. All types of implants can be treated with these different tip sizes.



Debridement of narrow implant threads, right-oriented

Pure titanium tip with a pointed extremity suitable to reach the inner-most parts of narrow implant threads.



IP1
F02121



IP2L
F02122



IP2R
F02123



IP3L
F02124



IP3R
F02125

The black ring on these tips indicates their exclusive use on titanium. Max. Power = 5 (green)

endosuccess canal access prep

The micro-blades are less aggressive than diamond and their coating makes these tips very durable.

F88180

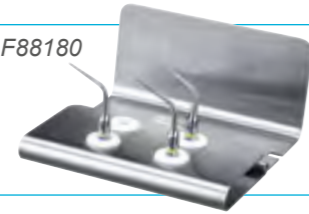

CAP1, CAP2, CAP3 tips, autoclavable metal support and universal wrench



CAP1
F88181



CAP2
F88182



CAP3
F88183



ET18D
F88017



ETBD
F88020



Canal access preparation



CAP1

Micro-blade tip length 12mm, taper 6%

Active lateral part for:

- Finishing walls and polishing.
- Removing temporary cement and dentinal residues.
- Removing dentin overhangs.

Non-active end to prevent the risk of perforating the pulp chamber floor.



CAP2

Micro-blade tip, length 9mm, taper 5%

Active lateral part and extremity used by sweeping method to remove dentine bridges.

- Location of the MB2 (2nd mesiobuccal canal) and search for hidden canals.
- Preparation of the pulp chamber.
- Removal of the dentine layer which may hide the access to the MB2 canal.



CAP3

Micro-blade tip, length 8mm, taper 6%

The CAP3 tip has a very pointed extremity indicated for:

- Locating and opening the calcified canals.
- Fragmenting calcifications or pulp stones in the pulp chamber.
- Loosening fiber posts.
- Locating accessory canals.

Due to its very sharp point, the CAP3 tip must be handled with care (visual aids recommended).



ET18D

Diamond-coated steel tip 76µm, length 18mm, taper 5%

- Finishing the access cavity.
- Removing dentine overhangs, calcifications and filling materials.



ETBD

Diamond-coated ball tip, length 20mm, taper 5%

Searching for canals and locating calcified canals.

irrisafe



IRRI20,25

Irrigation



IRRISAFE

Passive ultrasonic irrigation (PUI) files of different lengths and diameters

Irrisafe™ safely* eliminates the smear layer, dentine debris and bacteria from the root canal. Its blunt tip prevents any risk of perforating the apex or the canal walls.

Irrigation once the root canal has been prepared.

- 20ml of irrigant (NaOCl) are injected into the canal.
- Irrisafe™ is inserted 2mm short of the working length and activated by performing withdrawal movements to flush the debris and the smear layer upwards.
- Repeated 3x 1 minute in each canal.



K FILES

Files of different lengths and diameters, taper 2%

Irrigation, withdrawal of calcified dentine and gutta percha, and withdrawal of broken instruments.

For irrigation ultrasonic files are used with a disinfectant solution. To provide a final decontamination, use sodium hypochlorite until the smear layer is removed.

K files are very sharp instruments and should be handled with precision. However they are flexible and can therefore be pre-bent.

K10, 15, 25, 30
FILES

* Van Der Sluis L.W.M. Passive ultrasonic irrigation of the root canal: a review of the literature. Int. Endodont. J. 2007; 40; 4: 415-428

endosuccess retreatment



ET20
F88011



ET20D
F88013



ET25
F88018



ET25S
F88021

F00737



ET18D, ET20, ET25, ET25S, ETBD, ETPR tips, autoclavable metal support and universal wrench



Canal Retreatment

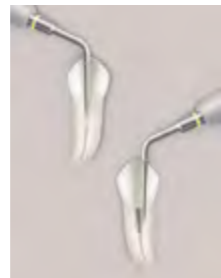

ET20 **Retreatment tip, length 20mm, taper 6%**
Used in the 1st coronal third:
• Extraction of filling material, silver points, broken instruments.
• Removal of debris and the smear layer.



ET20D **Diamond-coated retreatment tip, 30 µm, length 20mm, taper 5%**
Used in the 1st coronal third to remove very hard materials by brushing the walls. The diamond coating of the ET20D tip increases the cutting and lateral abrasion effect.

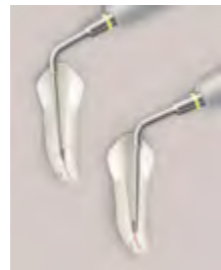

ET25 **Titanium-Niobium tip, length 20mm, taper 3%**
Retreatment in the middle and apical thirds and the extraction of broken instruments. The Titanium-Niobium alloy of the ET25 range allows perfect transmission of the ultrasonic vibrations and tip flexibility*.



ET25S **Short Titanium-Niobium tip, length 15mm, taper 4%**
Retreatment in the coronal third and the isthmuses.

* E.W. Collings Applied superconductivity, metallurgy and physics of titanium alloys 1985

endodontics



F00732
endo
one



Endodontic treatments CAP1, CAP2, CAP3, ET25, ETPR tips, 4 Irrisafe 25-21 mm blister, autoclavable metal support and universal wrench



Retreatment and obturation



ET40 **Long retreatment tip, 40mm, taper 4%**
Rapid removal of broken instruments in the middle third of wide, straight canals.



ET40D **Long retreatment tip, 40mm, diamond-coated 30 µm, taper 4%**
Retreatment of very hard material in the middle third.



ET25L **Long Titanium-Niobium tip, 25mm, taper 3%**
Retreatment in the apical third and long, straight canals.

ET25 tips can be pre-formed for the treatment of curved canals.



SO4 **Fine condenser, length 40mm, taper 4%**
Lateral condensation of gutta percha by heating effect. It is used dry, without irrigation.



ET40
F88012



ET40D
F88014



ET25L
F88022



SO4
F88009

endosuccess apical surgery

F00069



AS3D, AS6D, AS9D, ASLD, ASRD tips, autoclavable metal support and universal wrench



AS3D
F00065



AS6D
F00079



AS9D
F00067



ASRD
F00081

ASLD
F00080

Apical surgery

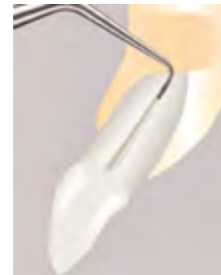

Diamond-coated universal tip 30µm, length 3mm, taper 9%
Apical surgery of anterior teeth. It should be used without pressure, at the lowest possible effective power.

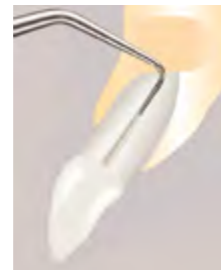

Diamond-coated tip 30µm, length 6mm, taper 9%
Second instrument in the sequence, used to obtain a preparation length of 5mm at least.

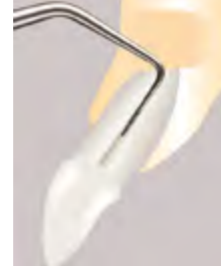

Diamond-coated tip 30µm, length 9mm, taper 8%
Used for complex cases and for the preparation of the root canal up to the coronal third. The diamond coating is only present on the extremity of the instrument not to over-prepare the canal.
The AS9D tip should first be introduced into the canal and oriented in the root axis before being activated to prevent the creation of a «false route».



Right-oriented tip, diamond-coated 30µm, length 3mm, taper 10%
Apical surgery of premolars and molars.



Left-oriented tip, diamond-coated 30µm, length 3mm, taper 10%
Apical surgery of premolars and molars.
It should be used with very light pressure.

endosurgery



S12-70D
F00118

Retro surgery



Retro surgery tip angled at 70°, diamond-coated 30µm, length 5mm, taper 9%
Treatment of posterior areas, in canals that are difficult to access or roots with specific orientations.

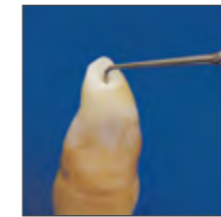

Universal retro surgery tip, diamond-coated 30µm, length 5mm, taper 7%
Preparation of canals in anterior teeth. The micro-retro tips make minimum treatment possible providing fast healing.



Left-oriented retro surgery tip, diamond-coated 30µm, length 5mm, taper 7%
Preparation of premolar and molar canals.



Right-oriented retro surgery tip, diamond-coated 30µm, length 5mm, taper 7%
Preparation of premolar and molar canals.

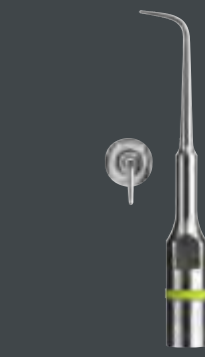

P14D
F00106



P15LD
F00107



P15RD
F00108

perfect margin rounded

F00738



PM1, PM2, PM3, PM4 tips,
autoclavable metal support and
universal wrench



PM1
F02250



PM2
F02251



PM3
F02252



PM4
F02253

Prosthetic finishing with chamfered shape



PM1

Preparation, rounded edge, diamond-coated tip 76 µm

First instrument of the ultrasonic sequence, following the rotary phase. Intrasulcular dentin preparation and positioning of finishing line.



PM2

Finishing, rounded edge, diamond-coated tip 46 µm

Correction of irregularities in the finish line and start of polishing. Its diamond coating, less dense than on the PM1, makes it possible to obtain a cutting edge finish.



PM3

Polishing, rounded edge, smooth

This entirely smooth instrument is last in the finishing sequence, improving the condition of the surface at the cervical limit before impression taking.



PM4

Corono-radicular preparation, conical, diamond-coated 46 µm

After the rotating phase, the PM4 tip is used to:

- Prepare the upper 1/3 of canal chamber.
- Shape anatomically the connection cone.
- Clean the root walls.
- Smooth the entry cones for the anatomical posts.

Loosening and condensation



5AE
F00249



C20
F00113



ETPR
F88019

5AE

Loosening of root canal posts with spray

Apply the 5AE tip on the lingual or palatine surface and the buccal surface, before finishing with the occlusal surface. Use the flat extremity of the instrument held firmly against the tooth.

C20

Condensation, Piezocem

For inlays or onlays on posterior teeth.

Perform sequences of 10 sec each time, until the prosthesis is perfectly integrated into the cavity. In general 2 or 3 sequences are sufficient; after each sequence remove the excess cement from the margin edges.

ETPR

Loosening tip (post removal)

The ETPR tip has profiled and concave shape. It provides greater efficacy on the posterior teeth.



Efficacy and safety

Choose the **ACTEON® Original tips** to get the full performance of your **Newtron® ultrasounds generator**

ACTEON® Original tips certify performance and safety

Our genuine ACTEON® tips have been designed to bring the best performance, efficiency and safety with Newtron®. ACTEON®'s liability - both legal and with regard to the warranty of parts and accessories - can't be engaged for the damages that might arise from the use of other than ACTEON® Original tips, such as:

- Lack of performance
- Break-up of the device
- Safety of the patient



How to recognize a worn tip?

For a maximum performance and safety, tips must be renewed

The active part of the tip is located on the last 3 mm. When the tip is worn, the action is limited and some key indicators can help the practitioner to identify a worn tip:

- Lack of results, because the oscillation of the tip is limited
- Pain for the patient, because of the increase of the power needed
- Overwarming of the surface
- Fatigue for the practitioner, because more pressure is needed to have a good result

For an optimal performance and the safety of your patients, it is important to change the tips on a regular basis, and not use worn tips.

ACTEON® is providing a tip card which gives information on the wear of the tip.

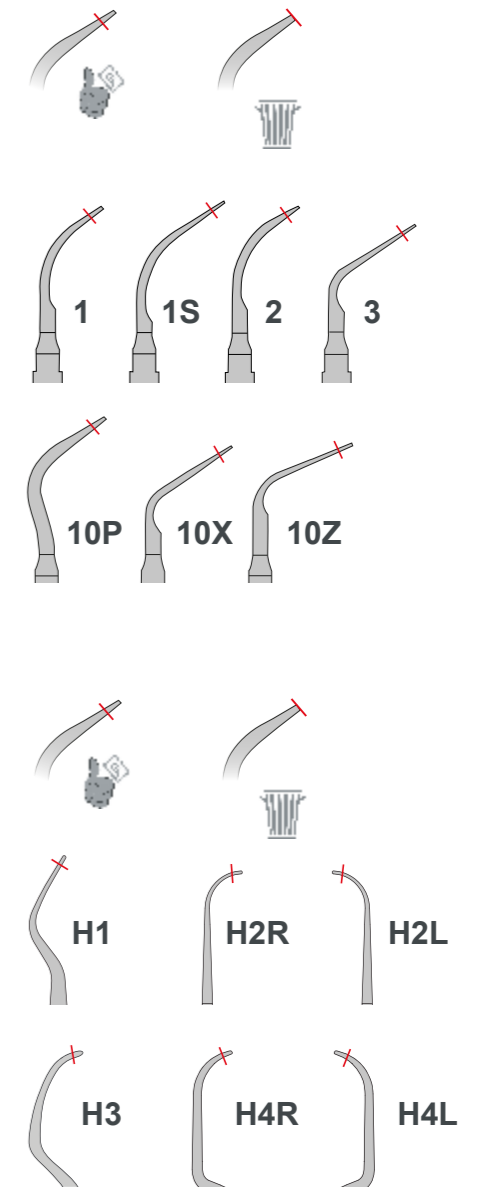





EN Fit the tip to the handpiece and place it on the edge of the card over the relevant diagram.

Tips settings recommendations

Tips	Newtron® Devices	POWER	IRRIGATION
------	---------------------	-------	------------



PROPHYLAXIS

1 / 2 / 3 / 1S		14	
10P		14	
10X / 10Z		12	
EX1* / EX2* / EX3* / EXL* / EXR*		12	

PERIODONTICS

H1 / H2L / H2R / H3 / H4L / H4R		2	
P2L / P2R		3	
TK1-1S		2	
TK1-1L / TK2-1L / TK2-1R		2	

IMPLANT CARE









PH1 / PH2L / PH2R		2	
IP1		3	
IP2L / IP2R / IP3L / IP3R		5	

ENDODONTICS









CAP1		10	
CAP2 / CAP3		10	
ET18D		10	
ET20 / ET25 / ET25S / ETBD		7	

Tips	Newtron® Devices	POWER	IRRIGATION
------	---------------------	-------	------------

ENDODONTICS

ET20D / ET25L / ET40 / ET40D		7	
IRR20-21 / IRR20-25 / IRR25-21 / IRR25-25		6	
K10 / K15 / K25 / K30		6	
AS3D / AS6D		7	
AS9D		6	
ASLD / ASRD		7	
P14D / S12-70D		7	
P15LD / P15RD		7	
SO4		7	

PROSTHESIS & ESTHETICS

PM1 / PMS1*		15	
PM2 / PMS2*		10	
PM3 / PMS3*		8	
PM4		15	
PMV1* / PMV2* / PMV3*		15	
PMV4* / PMV5* / PMV6*		10	
5AE / ETPR		20	
C20		11	



*These products are discontinued

Meet your expectations with Newtron® ultrasonic devices



newtron p5XS b-led

Versatile & autonomous

Handpiece: LED NEWTRON® SLIM B.LED blue ring (F12900) white ring (F12905)
Irrigation: 300ml tank (500ml tank in option: F62005)
Irrigation flow rate: 5 - 40 ml/min

Dental plaque disclosing liquid
F.L.A.G.™ for B.LED

Handpiece weight: 48g
Device weight: 2100g
Overall dimensions (LxWxH): 260x185x140mm

Non b-led option also available

newtron p5 b-led

Design & ergonomic

Handpiece: LED NEWTRON® SLIM B.LED blue ring (F12900) white ring (F12905)

Dental plaque disclosing liquid
F.L.A.G.™ for B.LED

Irrigation: Connected to the water supply
Pressure: 1 to 5 bars

Handpiece weight : 48g
Device weight: 1650g
Overall dimensions (LxWxH): 155x185x100mm

Non b-led option also available



newtron booster

Compact & efficient

Handpiece: Not LED SP NEWTRON® (F12281)
Overall dimensions (LxWxH): 129x160x87mm

Irrigation: Connected to the water supply
Pressure: 1 to 5 bars

Handpiece weight: 52g
Device weight: 1600g





About Prophylaxis workflow

This combination of solutions helps dentists easily prevent and diagnose potential dental problems such as periodontal disease and tooth decay. It also allows to perform safe and minimally invasive procedures, providing best care and comfort for patients.



Diagnosis

To ensure a reliable diagnosis, I need to get a quick and clear view of initial signs of caries, periodontal disease, and other conditions.

C50



C50 intraoral camera is the perfect companion for non-invasive and reliable caries detection, thanks to its fluorescent technology.



Treatment

I wish to carry out fast and accurate treatment, while reducing hand fatigue.



Newtron® P5XS B.LED and Bliss™ is the perfect combo to preserve tissues with efficacy and precision. Less force is needed for more comfort.



Air polishing

It is important for me to control the progression of the disease, without neglecting the comfort of my patient.

air-n-go easy



With Air-N-Go® easy, provide a gentle and effective treatment that limits bleeding. Stains and bacterial plaque are removed even in hard-to-reach areas.



Follow-up

In order to educate my patients for better treatment acceptance, I need to highlight the results of my dental care.

C50



C50 provides a reliable and immediate check of the clinical condition. The images can be shown to the patient and saved to his file.



Protection

I need to ensure optimal clinical protection for my patients and limit the risk of cross-contamination.



riskontrol

Riskontrol® disposable tips are your must-have solution to perform dental care in a safe and clean place. It assures protection, comfort and safety in every daily clinical procedures.



SATELEC

A company of ACTEON® Group

17 avenue Gustave Eiffel,
ZI du Phare,
33700 Mérignac, France

Tel. +33 (0) 556 340 607

Fax. +33 (0) 556 349 292

info@acteongroup.com

Follow-us

Newtron Booster, Newtron P5 XS, Newtron P5 XS B.Led: Dental Ultrasonic Control Console
Class IIa medical devices - CE0459 (GMED)
For professional dental use only.
Manufacturer: SATELEC® - France
Read carefully the instructions for use available on www.acteongroup.com
Updated on: 10/2023