

# OSTEOGENICS

## REGENERATION PRODUCTS CATALOG

[www.osteogenics.com](http://www.osteogenics.com) | 888.796.1923



**UNRIVALED**  
REGEN SOLUTIONS

## ORDERING

Our customer service professionals are available from 7 AM to 7 PM CST, Monday through Thursday, and 7 AM to 5 PM CST on Fridays. Orders may be placed by the following methods:

TOLL-FREE	1.888.796.1923 (US & Canada only)
INTERNATIONAL	+1 806.796.1923
FAX	806.796.0059
EMAIL	sales@osteogenics.com
WEBSITE	www.osteogenics.com
ADDRESS	Osteogenics Biomedical, Inc. 4620 71st Street   Building 78-79 Lubbock, TX 79424

## SHIPPING

Orders placed by 5 PM CST will be shipped the same day unless specified otherwise by your customer service professional. Standard shipping is 2nd Day delivery with UPS. Due to our volume discounts with UPS, our 2nd Day rate is usually less than standard ground shipping and assures better tracking and customer support. Overnight delivery is available at discounted rates as well.

## PRICING

Prices are subject to change. However, we will make every effort to notify you in advance of a change. We offer the following discounts on bulk purchases:

**Save with our  
Standard Bulk  
Discounts!**

**Buy 5, Get 1 FREE | Buy 12, Get 3 FREE | Buy 30, Get 10 FREE\***  
on all products except Pro-Fix™ kits, Meisinger kits, Master-Mill, and Hu-Friedy instruments.

*\*Mixing and matching different products is permitted; the least expensive product will be credited as free.*

## PAYMENT

We make it easy for you. We accept all major credit cards, or domestic orders may choose payment terms of Net 15. All payments are in US Dollars.

## AVAILABILITY

We know how frustrating back-orders are, so we carry enough inventory to ensure that, statistically, we have your product on hand 99% of the time. In the event of a back-order, we will notify you at the time of your order and give you an estimated ship date.

## SATISFACTION ASSURANCE

If you are not completely satisfied with our products, call us and we will arrange for a replacement, exchange, or refund. Unopened boxes may be returned within 30 days from the invoice date for a full refund. Opened boxes may be returned for product exchange within 90 days of the invoice date. Call customer service at 1.888.796.1923 for return authorizations.



## TABLE OF CONTENTS

	<b>SOFT TISSUE GRAFTING</b>
4	• Cytoplast MicroDerm™
	<b>BONE GRAFT MATERIALS</b>
6	enCore® Allografts
8	Zcore™ Porcine Xenograft Particulate
10	Zcore™ Form Moldable Collagen-Enriched Porcine Xenograft
11	Zcore™ Expand Collagen-Enriched Porcine Xenograft
12	NovaBone® Dental Putty & Morsels
	<b>RESORBABLE BARRIER MEMBRANES</b>
14	Cytoplast™ RTM Collagen
15	Cytoplast™ RTMPlug, RTMFoam, & RTMTape
16	Zmatrix™ Porcine Peritoneum Collagen
	<b>NON-RESORBABLE BARRIER MEMBRANES</b>
17	Cytoplast™ TXT-200 & TXT-200 Singles
17	Cytoplast™ Technique Ridge Preservation Kit
18	Cytoplast™ Ti-250 & Ti-150 Titanium-Reinforced
22	RPM™ Reinforced PTFE Mesh
26	Osteo-Mesh™ TM-300
	<b>SUTURE</b>
27	Cytoplast™ PTFE
28	• Resorba® Glycolon™
29	Resorba® PGA Resorba™
30	Resorba® Resolon™
31	Resorba® Resolon Twist™
	<b>FIXATION SYSTEMS</b>
32	Pro-Fix™ Membrane Fixation
33	Pro-Fix™ Tenting
34	Pro-Fix™ Bone Fixation
35	Master-Pin-Control
36	<b>Master-Mill &amp; Master-Core</b>
37	<b>Swann-Morton® Premium Micro-Serrated Blades</b>
	<b>BONE SCRAPERS</b>
38	Micross
38	Smartscraper
39	Safescraper® Twist – Curve
39	• Safescraper® Twist – Curve Volumizer
40	<b>SELECTION OF APPLICABLE REFERENCES</b>
	•

| *New Items Available*

All **PART NUMBERS** are denoted with a vertical bar



**NEW**

# Cytoplast MicroDerm™

Acellular dermal matrix with surface micro-cuts

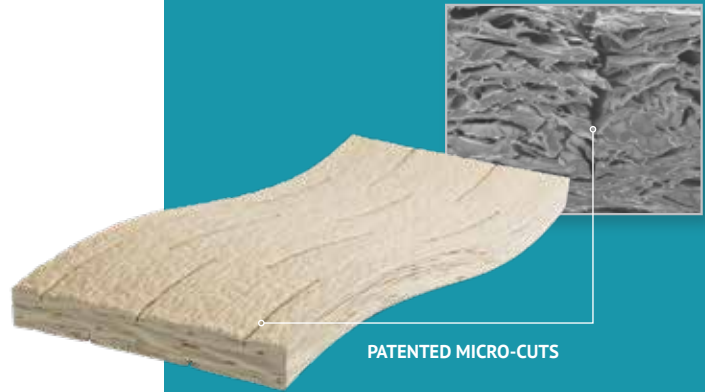

## BENEFITS OF MICRO-CUTS

- Increased surface area at the graft-to-host interface<sup>1</sup>
- Increased cellular infiltration<sup>1</sup>
- Increased hydrophilicity of graft
- Hydrates in 60 seconds
- Ease of trimming and suture placement

## TECHNICAL SPECIFICATIONS

- Acellular dermis meets or exceeds all FDA and AATB guidelines for safety
- Terminally sterilized to a SAL of 10<sup>-6</sup>
- Packaged dehydrated
- No antibiotics, no rinsing
- Not side specific

### Dual-sided cross-hatching to increase surface area

*Micro-cut channels shorten pathways for vascularization and increase tissue surface area available for attachment.*

Case Photos Provided by  
Shaun Rotenberg, DMD, MS

1. Pre-op
2. Cytoplast MicroDerm™ placed
3. Sutured
4. Two weeks post-op
5. Four months post-op

*Site treated with Cytoplast MicroDerm™ via a vestibular tunnel access approach and sutured with Glycolon™.*



1. Marinelli et al. Histologic Evaluation of Wound-Bed Preparedness Following Microsurfaced Skin Grafts for the Treatment of Deep Burn Wounds: Results from a Randomized Controlled Trial. Poster presented at 2023 AMSUS Annual Meeting; February 13, 2023; National Harbor, MD.

# Cytoplast MicroDerm™

Acellular dermal matrix with surface micro-cuts



“The *early healing* and *soft tissue appearance* is really *where Cytoplast MicroDerm™ shines*. Tissue never looks this good so early on with traditional allograft.”

Shaun Rotenberg  
Periodontist



After hydration, Cytoplast MicroDerm™ becomes soft and pliable.

**NEW**

hydrated

shown actual size

Thickness = 1.2 mm +/-0.2 mm

1 cm x 1 cm



| CMD1010 (1 per box)

1 cm x 2 cm



| CMD1020 (1 per box)

1 cm x 4 cm



| CMD1040 (1 per box)

2 cm x 4 cm



| CMD2040 (1 per box)

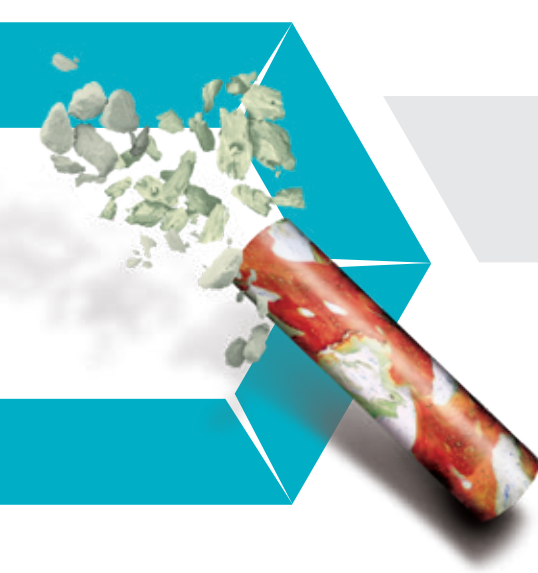

## A SYNERGISTIC COMBINATION

- Combines the synergistic characteristics of slowly resorbing, space-maintaining mineralized cortical bone with osteoinductive demineralized matrix to provide an optimized environment for the regeneration of vital bone

## CHAIR-SIDE EFFICIENCY

- 70/30 combination graft is pre-mixed to reduce inventory and reduce chair-side preparation
- Double-sterile packaged for aseptic presentation in the surgical field

## TESTED TWICE TO ENSURE ITS OSTEOINDUCTIVITY

- Pre-sterilization *in vitro* BMP-2 assay  
Prior to packaging and terminal sterilization, every lot is tested for a minimum threshold of BMP-2  
All lots that fail to meet the threshold are discarded
- Post-sterilization *in vivo* osteoinductivity verification  
Every lot undergoes a final *in vivo* post-sterilization test to verify its osteoinductive potential

## BEST PRACTICES IN SAFETY

- Tissue processed by Allotech, an FDA-registered and AATB accredited tissue bank
- Single donor per lot
- Terminally sterilized by low-dose e-beam irradiation to a sterility assurance level of  $10^{-6}$

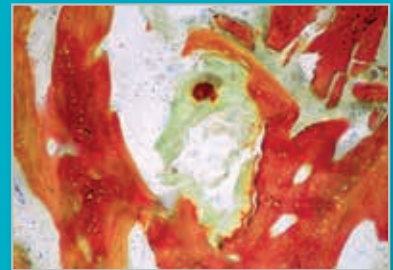
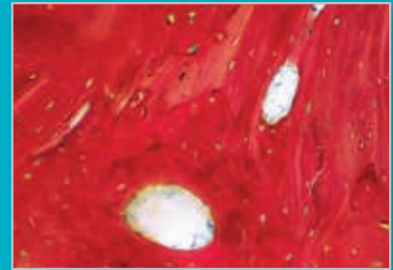

*Representative histology taken at 6 months from a case using combination allograft*

**86% vital bone**  
**14% residual graft**  
**51% bone, 49% Marrow**

Histology by Michael Rohrer, DDS, MS  
University of Minnesota

**enCore® 70|30 Combination Allograft (FDBA & DFDBA)**

70% Mineralized Cortical Allograft and 30% Demineralized Allograft

**0.25 mm - 1.0 mm Particle Size**

0.5 cc	C73050	(1 per box)
1.0 cc	C73100	(1 per box)
1.5 cc	C73150	(1 per box)
2.5 cc	C73250	(1 per box)



**enCore® 50|50 Cortical & Cancellous Allograft**

50% Mineralized Cortical Allograft and 50% Mineralized Cancellous Allograft

**0.5 mm - 1.25 mm Particle Size**

0.5 cc	CM55050	(1 per box)
1.0 cc	CM55100	(1 per box)
1.5 cc	CM55150	(1 per box)
2.5 cc	CM55250	(1 per box)



**enCore® OD 30|70 Cortical & Cancellous Allograft**

30% Mineralized Cortical Allograft and 70% Mineralized Cancellous Allograft

**0.25 mm - 1.0 mm Particle Size**

0.5 cc	OD37050	(1 per box)
1.0 cc	OD37100	(1 per box)
2.5 cc	OD37250	(1 per box)



**enCore® Mineralized Cortical Allograft**

100% Mineralized Cortical Allograft

**.25 mm - 1.0 mm Particle Size**

0.5 cc	SMIN050	(1 per box)
1.0 cc	SMIN100	(1 per box)
1.5 cc	SMIN150	(1 per box)
2.5 cc	SMIN250	(1 per box)





Zcore™ is an osteoconductive, porous, anorganic bone mineral with a carbonate apatite structure derived from porcine cancellous bone.

## INTERCONNECTING PORES

Interconnecting macroscopic and microscopic porous structure supports the formation and ingrowth of new bone

## 88% TO 95% VOID SPACE

88% to 95% Void Space: hyper-porosity of porcine cancellous matrix and intra-particle space facilitated by rough particle morphology reduce bulk density of the graft, allowing greater empty space for new bone growth\*

## PORCINE CANCELLOUS BONE

Derived from porcine cancellous bone, eliminating risk of BSE transmission

## PROCESSED USING MINIMAL HEAT

Heat treated to an optimal temperature that ensures a degree of crystallinity<sup>1</sup> consistent with native bone mineral to allow for remodeling of the healing bone

\*0.25 mm - 1.0 mm particle size = 88% void space, 1.0 mm - 2.0 mm = 95% void space

1. Li ST, Chen HC, Yuen D. Isolation and Characterization of a Porous Carbonate Apatite From Porcine Cancellous Bone. *Science, Technology, Innovation*, Aug. 2014: 1-13.

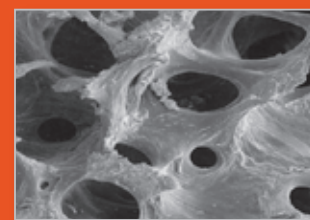
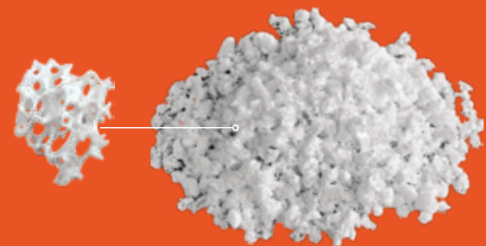

**SEM of Processed Human Bone**  
Magnification x50

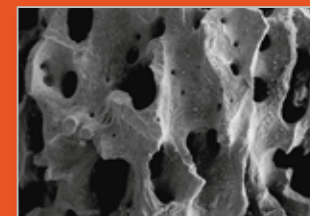

**SEM of Zcore™ Porcine Xenograft Particulate**  
Magnification x50



# Zcore™

Porcine Xenograft Particulate

## Zcore™ Porcine Xenograft Particulate

### .25 mm - 1.0 mm Particle Size

0.5 cc	ZS050	(1 per box)
1.0 cc	ZS100	(1 per box)
2.0 cc	ZS200	(1 per box)
4.0 cc	ZS400	(1 per box)



### 1.0 mm - 2.0 mm Particle Size

1.0 cc	ZL100	(1 per box)
2.0 cc	ZL200	(1 per box)

## Zcore™ Porcine Xenograft Particulate in Syringe

### .25 mm - 1.0 mm Particle Size

0.25 cc	ZY025	(1 per box)
0.5 cc	ZY050	(1 per box)



not actual size

**NEW**

# Zcore™ Form

Moldable Collagen-Enriched Porcine Xenograft



shown actual size

**9 mm diam. x 8 mm**

0.5 cc | ZF050 (1 per box)



**11 mm diam. x 12 mm**

1.0 cc | ZF100 (1 per box)



**11 mm diam. x 22 mm**

2.0 cc | ZF200 (1 per box)



*Zcore™ Form hydrates almost immediately when introduced to the patient's blood or sterile saline.*



*Once hydrated, Zcore™ Form becomes moldable and can take the shape of a variety of defect shapes and sizes.*

## **80% ZCORE™ PORCINE XENOGRAFT PARTICULATE 20% TYPE I PORCINE COLLAGEN**

A composite of osteoconductive bone mineral and collagen, Zcore™ Form is composed of 80% porcine xenograft particulate and 20% porcine collagen by volume (90% xenograft and 10% collagen by weight). The moldable consistency allows it to take the shape of the defect while also making the overall handling of the product easier and more convenient than particulate grafts.

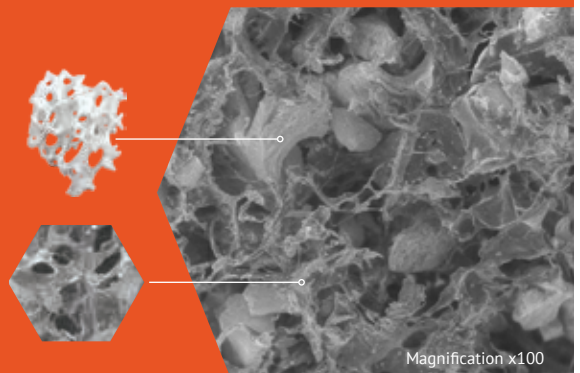

Magnification x100

# Zcore™ Expand

Expandable Collagen-Enriched Porcine Xenograft

**NEW**

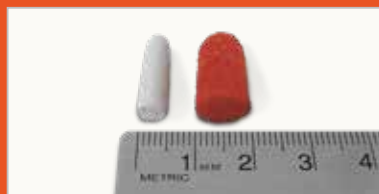

Zcore™ Expand hydrates and expands almost immediately when introduced to the patient's blood or sterile saline.



Once hydrated, Zcore™ Expand increases in diameter to fill the void space in a socket or sinus defect.

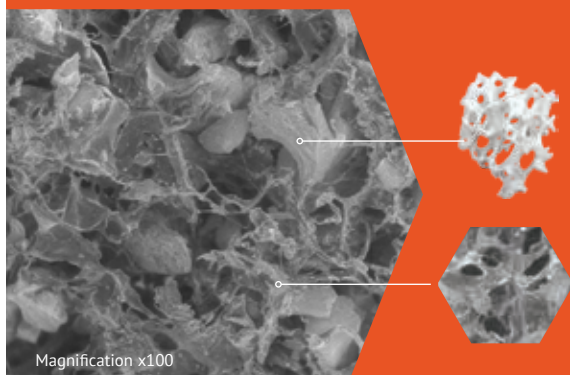

Magnification x100



## Socket

5 mm x 17 mm  
10 mm x 17 mm EXPANDED

- | ZXSOCKET (1 unit)
- | ZXSOCKET-5 (5 units)
- | ZXSOCKET-10 (10 units)
- | ZXSOCKET-20 (20 units)

shown actual size



## Small Sinus

13 mm diam. x 10 mm  
17 mm x 10 mm EXPANDED

- | ZX SINUSS (1 unit)

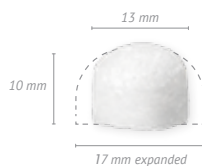

## Large Sinus

17 mm diam. x 12 mm  
22 mm x 12 mm EXPANDED

- | ZX SINUSL (1 unit)

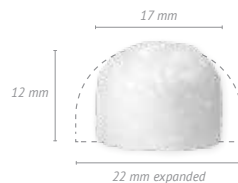

## 65% ZCORE™ PORCINE XENOGRAFT PARTICULATE 35% TYPE I EXPANDABLE PORCINE COLLAGEN

A composite of osteoconductive bone mineral and expandable collagen, Zcore™ Expand is composed of 65% porcine xenograft particulate and 35% porcine collagen by volume (80% xenograft and 20% collagen by weight). Zcore™ Expand is supplied as a compressed preformed sponge that expands when hydrated, allowing it to take the shape of the defect. The unique expandable property makes Zcore™ Expand a desirable option for extraction site grafting and/or sinus augmentation that uses a lateral approach.

# NovaBone® Dental Putty & NovaBone® Morsels

*The synthetic solution to bone regeneration*



## UNIQUE FORMULATION OF NOVABONE® DENTAL PUTTY

NovaBone® Putty is 100% synthetic and fully resorbable. It is composed of calcium phosphosilicate (CPS) particles in a bimodal size distribution combined with a polyethylene glycol and glycerine binder. The binder improves handling and aids in maintaining the space between the particles, which facilitates revascularization after implantation. The bioactive CPS component makes up 70% of the putty by volume. Upon implantation, the water soluble binder is absorbed within 24 to 72 hours, creating a 3-dimensional porous scaffold that facilitates diffusion of blood and tissue fluids through the matrix. The smaller CPS particles (32-125 µm) are more rapidly resorbed, providing the initial burst of Ca and P ions. Subsequently, the larger particles (90-710 µm) react, and being more resistant to resorption, continue the process of bone regeneration.

## OSTEOSTIMULATIVE & OSTEOCONDUCTIVE

Unlike most synthetic grafts that are only osteoconductive, bioactive NovaBone® Putty also has an “osteostimulative” effect. After implantation, surface reactions result in absorption of the graft material, a controlled release of Si, Ca, and P ions, and concurrent new bone formation. These surface reactions result in an osteostimulative effect, defined as the stimulation of osteoblast proliferation in vitro as evidenced by increased DNA content and elevated osteocalcin and alkaline phosphatase levels. In vitro gene array analysis has confirmed that when human primary osteoblasts are exposed to extracts of CPS, upregulation of several gene families occurs.

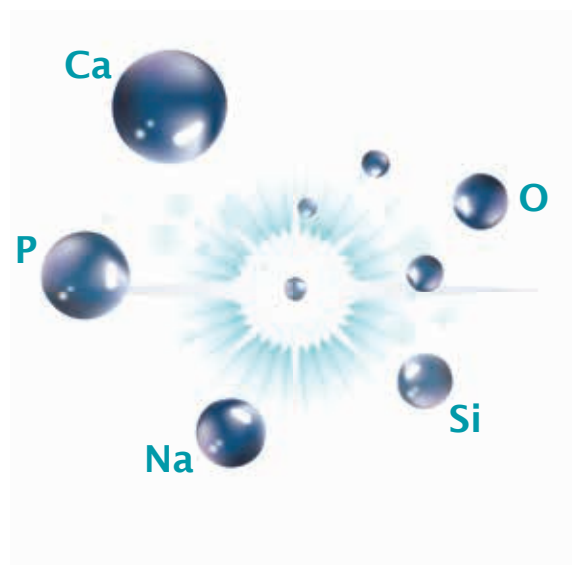

## SUPERIOR DELIVERY SYSTEM & HANDLING

NovaBone® Putty is available in multiple delivery options: trays, pre-filled syringes, and a unique industry-first cartridge delivery system. NovaBone® is the only graft material in the world that is available in disposable uni-dose cartridges. The cartridges simplify dispensing of the graft, especially in hard-to-reach areas, thus facilitating minimally invasive techniques (and hard-to-access defects such as gaps in immediate implant placement and crestal-approach sinus lifts). Cartridges are available in various sizes and are used in conjunction with NovaBone®'s cartridge delivery system; each cartridge holds 0.25 to 0.5 cc's of putty.

NovaBone® Putty significantly simplifies bone graft handling and delivery. It is ready to use and extremely user friendly. It is pre-mixed, cohesive, moldable, and adaptable. NovaBone® Putty is stable at room temperature, does not require refrigeration, has a 4-year shelf-life, and appears radiodense on radiographs.

# NovaBone® Dental Putty & NovaBone® Morsels

The synthetic solution to bone regeneration



“It’s *amazing* for vertical approach sinus lifts in conjunction with implant placement! It lifts the membrane more predictability than other graft materials I’ve used, and it’s more apparent on the x-ray due to radiopacity. I’m very happy and impressed with NovaBone™! I now feel I have greater predictability with vertical approach sinus lifts, and I’m doing it in situations when I would have previously used a lateral window approach to the sinus lift. *The results have been fantastic!*”

Scott Price, DDS  
Periodontist

NovaBone® Morsels is a particulate product made up of a crystalline composite calcium phosphosilicate (CPS). The particle size ranges from 0.5 mm - 1.0 mm with pore sizes ranging from 0.05 mm - 0.10 mm. The pore size results in slow and sustained resorption that is completed over a 12-18 month period. The morsels have an “osteostimulative” effect similar to NovaBone® Dental Putty.

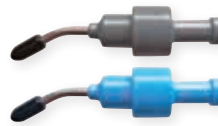

## NovaBone® Putty in Cartridges

### Cartridges

0.25 cc	NA4640	(4 per box)
0.5 cc	NA3620	(2 per box)
0.5 cc	NA3660	(6 per box)



### Cartridge Applicator Gun

NA4600	(Fits all cartridges)
--------	-----------------------



## NovaBone® Putty in Syringes

0.5 cc	NA1610	(1 per box)
1.0 cc	NA1611	(1 per box)
2.0 cc	NA1612	(1 per box)



not actual size

## NovaBone® Morsels in Trays

1.3 cc	EU0820	(2 per box)
--------	--------	-------------

# Cytoplast™ RTM Collagen

Type I bovine collagen membrane



15 mm x 20 mm

| RTM1520 (2 per box)

shown actual size



20 mm x 30 mm

| RTM2030 (2 per box)



30 mm x 40 mm

| RTM3040 (2 per box)



“...I am impressed with its **handling**, but most importantly, I am impressed with its **results**.”

*Jerald Rosenberg, DMD  
Periodontist*

## MANUFACTURED FROM HIGHLY PURIFIED TYPE 1 BOVINE ACHILLES TENDON

Safe for the patient

## 26 – 38 WEEK RESORPTION TIME

Long predictable resorption time limits the risk of particle loss due to premature resorption

## HIGH TENSILE STRENGTH

You can suture or tack the membrane in place without tearing

## CELL OCCLUSIVE

Prevents epithelial down growth

## OPTIMIZED FLEXIBILITY

Stiff enough for easy placement, yet easily drapes over ridge

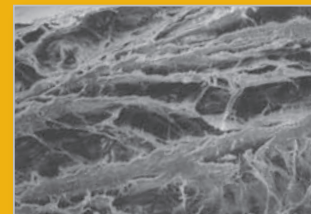

*Reconstituted fiber construction allows tissue integration while preventing direct passage of epithelial cells.*

# Cytoplast™ RTMPlug, RTMFoam, & RTMTape

Absorbable Wound Dressing | Type I & Type III bovine collagen



shown actual size



## RTMPlug

1 cm x 2 cm

| RTMPLUG10 (10 per box)



## RTMFoam

2 cm x 4 cm (3 mm thick)

| RTMFOAM10 (10 per box)

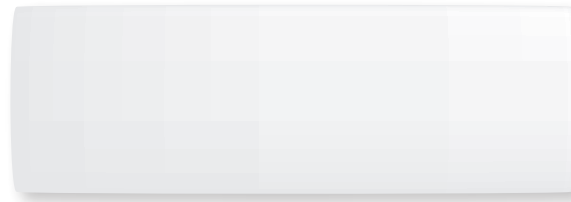

## RTMTape

2.5 cm x 7.5 cm (1 mm thick)

| RTMTAPE10 (10 per box)



Wound dressings will be essentially resorbed within 30 days

## APPLICATIONS

- Surgical wounds
- Periodontal surgical wounds
- Extraction sites
- Dental sores
- Oral ulcers (non-infected or viral)
- Suture sites
- Burns
- Traumatic wounds



*A perfectly soft consistency that drapes without the usual self-adherence experienced with other natural collagen membranes.*

shown actual size

**15 mm x 20 mm**

| ZM1520 (1 per box)



**25 mm x 30 mm**

| ZM2530 (1 per box)



**30 mm x 40 mm**

| ZM3040 (1 per box)



## EASY HANDLING

- Does not stick to instruments or itself
- Either side can face the defect
- Low surface expansion when hydrated

## HIGH TENSILE STRENGTH<sup>1</sup>

- High suture retention
- High tear resistance

## FACILITATES NEW BONE FORMATION<sup>2,3</sup>

- Significantly higher new bone formation in the central portion of the defect, in comparative *in vivo* study

1. Gasser A, et al. *J Dent Res* 2016;95 (Spec Iss A): 1683 2. Wessing B, et al. *Clin Oral Impl Res*; 2017;28(11):e218-e226 3. Omar O, et al. *Clin Oral Impl Res*; 2018;29(1):7-19



# Cytoplast™ TXT-200 & TXT-200 Singles

Micro-textured, high-density PTFE membrane



“I always know, *in advance*, the results of my bone grafting when I use Cytoplast™ TXT-200 as a membrane. *Why bother with other membranes?*”

Mark Cohen, DDS  
Periodontist

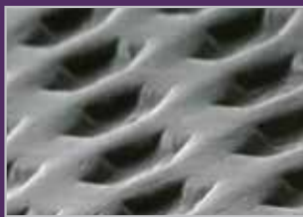

The patented Regentex™ surface helps stabilize the membrane and the soft tissue flap. Hexagonal surface dimples provide a textured surface that increases the area available for cellular attachment without increasing porosity. U.S. Patent #5,957,690

shown actual size

**MOST POPULAR SOCKET GRAFTING MEMBRANE**



## TXT-200 Singles

12 mm x 24 mm

| TXT1224-1 (1 per box)

| TXT1224 (10 per box)

## NEW TXT-200

12 mm x 30 mm

| TXT1230 (10 per box)

## TXT-200

25 mm x 30 mm

| TXT2530-1 (1 per box)

| TXT2530 (4 per box)

## NON-RESORBABLE

Won't resorb prematurely – you dictate healing time

## 100% DENSE (NON-EXPANDED) PTFE

Impervious to bacteria (pore size less than 0.3 µm) *Data on file*

## PURPOSELY LEAVE THE MEMBRANE EXPOSED

Preservation of the soft tissue architecture and keratinized mucosa

## HEXAGONAL DIMPLES INCREASE SURFACE AREA

Designed to increase membrane stabilization



## Cytoplast™ Technique Ridge Preservation Kit

| KITRPCT

(1) enCore® 70/30 Combination Allograft 0.5 cc

(1) Cytoplast™ TXT-200 Single

(1) Cytoplast™ PTFE Suture USP 3/0; 16 mm RC needle



# Cytoplast™ Titanium-Reinforced

Titanium-reinforced, high-density PTFE membrane

Ti-250 (250 µm thick)	Ti-150 (150 µm thick)
--------------------------	--------------------------

## ANL

12 mm x 24 mm

Ti250ANL-N-1	Ti150ANL-N-1	(1 per box)
Ti250ANL-N-2	Ti150ANL-N-2	(2 per box)

Designed for narrow single-tooth extraction sites, especially where one bony wall is missing

## ANL30

12 mm x 30 mm

Ti250ANL30-N-1	(1 per box)
Ti250ANL30-N-2	(2 per box)

Designed for narrow single-tooth extraction sites, especially where one bony wall is missing

## PS

20 mm x 25 mm

Ti250PS-N-1	Ti150PS-N-1	(1 per box)
Ti250PS-N-2	Ti150PS-N-2	(2 per box)

Designed for large extraction sites and limited ridge augmentation

## PL

25 mm x 30 mm

Ti250PL-N-1	Ti150PL-N-1	(1 per box)
Ti250PL-N-2	Ti150PL-N-2	(2 per box)

Designed for large bony defects, including ridge augmentation

### VERSATILE RECTANGULAR SHAPES

These configurations can be trimmed to fit a variety of defects.

Shown actual size.



# Cytoplast™ Titanium-Reinforced

Titanium-reinforced, high-density PTFE membrane



## VERSATILE RECTANGULAR SHAPES

These configurations can be trimmed to fit a variety of defects.

Shown actual size.



\*Ti-150 membranes are 40% thinner than Ti-250 membranes, providing clinicians another handling option in Cytoplast™ Titanium-Reinforced Membranes.

Ti-250 (250 µm thick)	Ti-150 (150 µm thick)
--------------------------	--------------------------

## XL

30 mm x 40 mm

Ti250XL-N-1	Ti150XL-N-1	(1 per box)
Ti250XL-N-2	Ti150XL-N-2	(2 per box)

Designed for very large bony defects, including ridge augmentation

## XLK

30 mm x 40 mm

Ti250XLK-N-1	Ti150XLK-N-1	(1 per box)
Ti250XLK-N-2	Ti150XLK-N-2	(2 per box)

Designed for very large bony defects, including ridge augmentation

## K2

40 mm x 50 mm

Ti250K2-N-1	Ti150K2-N-1	(1 per box)
Ti250K2-N-2	Ti150K2-N-2	(2 per box)

Designed for the largest bony defects, including ridge augmentation



# Cytoplast™ Titanium-Reinforced

Titanium-reinforced, high-density PTFE membrane

Dimensional measurements shown in mm.  
Width measurements noted at widest point  
and narrowest point. Shown actual size.

## INTERPROXIMAL SHAPES

These configurations are designed  
to fit between existing teeth.

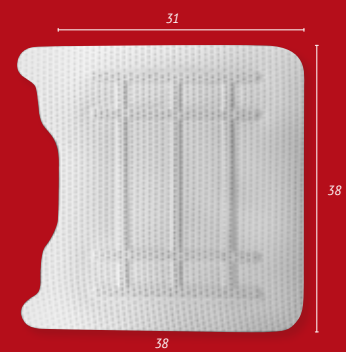
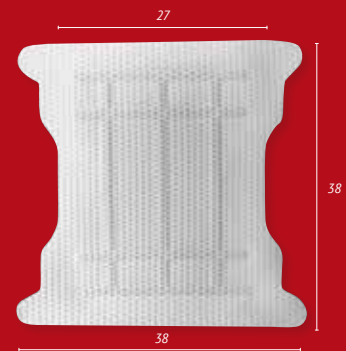

Ti-250 (250 µm thick)	Ti-150 (150 µm thick)
--------------------------	--------------------------

## AS

14 mm x 24 mm

Ti250AS-N-1	Ti150AS-N-1	(1 per box)
Ti250AS-N-2	Ti150AS-N-2	(2 per box)

Designed for single-tooth extraction sites, especially  
where one or more bony walls are missing

## ATC

24 mm x 38 mm

Ti250ATC-N-1	Ti150ATC-N-1	(1 per box)
Ti250ATC-N-2	Ti150ATC-N-2	(2 per box)

Designed for large extraction sites, including ridge  
augmentation

## PTC

38 mm x 38 mm

Ti250PTC-N-1	Ti150PTC-N-1	(1 per box)
Ti250PTC-N-2	Ti150PTC-N-2	(2 per box)

Designed for large bony defects, including ridge  
augmentation

## PD

38 mm x 38 mm

Ti250PD-N-1	Ti150PD-N-1	(1 per box)
Ti250PD-N-2	Ti150PD-N-2	(2 per box)

Designed for large bony defects, including distal  
extension of the posterior ridge

# Cytoplast™ Titanium-Reinforced

Titanium-reinforced, high-density PTFE membrane

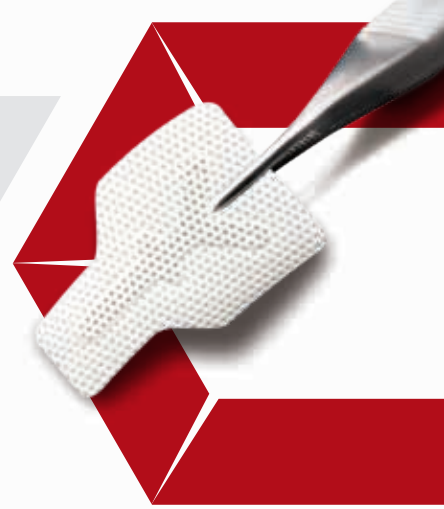

Dimensional measurements shown in mm.  
Width measurements noted at widest point  
and narrowest point. Shown actual size.

## SHAPES WITH FIXATION POINTS

These configurations are designed with  
fixation points outside of the defect area.

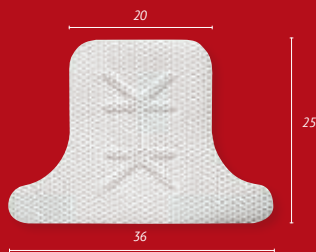

Ti-250 (250 µm thick)	Ti-150 (150 µm thick)
--------------------------	--------------------------

## BL

17 mm x 25 mm

Ti250BL-N-1	Ti150BL-N-1	(1 per box)
Ti250BL-N-2	Ti150BL-N-2	(2 per box)

*Designed for large buccal defects*

## NEW BLL

17 mm x 30 mm

Ti250BLL-N-1	Ti150BLL-N-1	(1 per box)
Ti250BLL-N-2	Ti150BLL-N-2	(2 per box)

*Designed for large buccal defects*

## PST

36 mm x 25 mm

Ti250PST-N-1	Ti150PST-N-1	(1 per box)
Ti250PST-N-2	Ti150PST-N-2	(2 per box)

*Designed for large extraction sites and limited ridge  
augmentation in the anterior maxilla*

## PLT

41 mm x 30 mm

Ti250PLT-N-1	Ti150PLT-N-1	(1 per box)
Ti250PLT-N-2	Ti150PLT-N-2	(2 per box)

*Designed for large bony defects, including ridge  
augmentation in the anterior maxilla*



**CIRCULAR MACROPORES**

Allow direct contact between the bone graft and periosteum, allowing naturally occurring revascularization and infiltration of cells into the bone graft

**TITANIUM FRAME**

Maintains space essential for horizontal and vertical ridge augmentation

**PTFE MESH**

Easily conforms to tissue contours

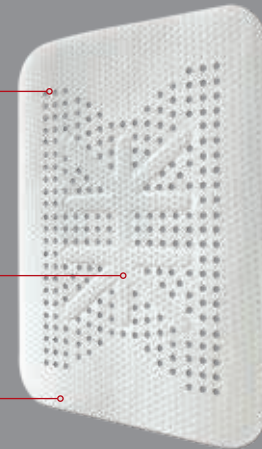

*Hybrid Approach: Adaptability of a membrane with the porosity of a mesh*

**BL**

17 mm x 25 mm

| RPM200BL (1 per box)

*Designed for large buccal defects*

**NEW BLL**

17 mm x 30 mm

| RPM200BLL (1 per box)

*Designed for large buccal defects*

**PST**

36 mm x 25 mm

| RPM200PST (1 per box)

*Designed for large extraction sites and limited ridge augmentation in the anterior maxilla*

**PLT**

41 mm x 30 mm

| RPM200PLT (1 per box)

*Designed for large bony defects, including ridge augmentation in the anterior maxilla*

**SHAPES WITH FIXATION POINTS**

These configurations are designed with fixation points outside of the defect area.

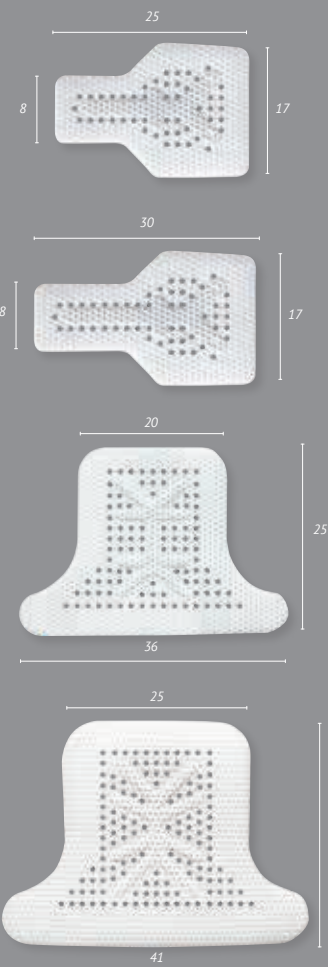

# RPM™

Reinforced PTFE mesh

## VERSATILE RECTANGULAR SHAPES

These configurations can be trimmed to fit a variety of defects. Shown actual size.

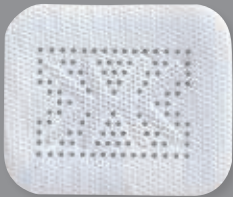

### PS

20 mm x 25 mm

| RPM200PS (1 per box)

*Designed for large extraction sites and limited ridge augmentation*

### PL

25 mm x 30 mm

| RPM200PL (1 per box)

*Designed for large bony defects, including ridge augmentation*

### XLK

30 mm x 40 mm

| RPM200XLK (1 per box)

*Designed for very large bony defects, including ridge augmentation*

### XLKM (mandible)

30 mm x 40 mm

| RPM200XLKM (1 per box)

*Designed for very large bony defects, including mandibular ridge augmentation NOTE: Non-perforated region is designed for lingual aspect*

### XL

30 mm x 40 mm

| RPM200XL (1 per box)

*Designed for very large bony defects, including ridge augmentation*

### K2

40 mm x 50 mm

| RPM200K2 (1 per box)

*Designed for the largest bony defects, including ridge augmentation*



**ATC**

24 mm x 38 mm

| RPM200ATC (1 per box)

*Designed for large extraction sites, including ridge augmentation*

**ATCM (mandible)**

24 mm x 38 mm

| RPM200ATCM (1 per box)

*Designed for large extraction sites, including mandibular ridge augmentation NOTE: Non-perforated region is designed for lingual aspect*

**PTC**

38 mm x 38 mm

| RPM200PTC (1 per box)

*Designed for large bony defects, including ridge augmentation*

**PTCM (mandible)**

38 mm x 38 mm

| RPM200PTCM (1 per box)

*Designed for large bony defects, including mandibular ridge augmentation NOTE: Non-perforated region is designed for lingual aspect*

Dimensional measurements shown in mm. Width measurements noted at widest point and narrowest point. Shown actual size.

**INTERPROXIMAL SHAPES**

These configurations are designed to fit between existing teeth.

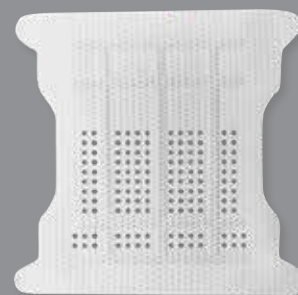
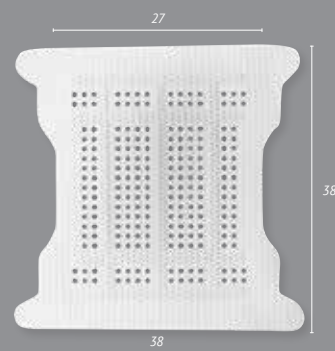



# RPM™

Reinforced PTFE mesh

Dimensional measurements shown in mm.  
Width measurements noted at widest point  
and narrowest point. Shown actual size.

## INTERPROXIMAL SHAPES

These configurations are designed  
to fit between existing teeth.

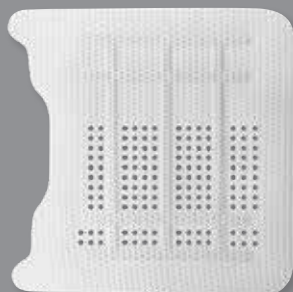
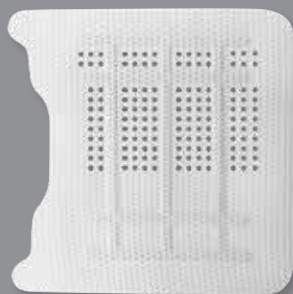
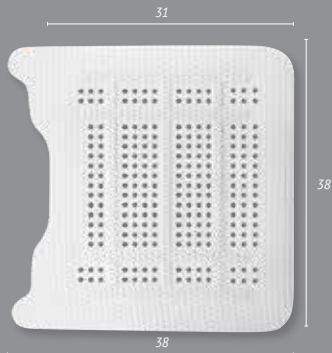

## PD

38 mm x 38 mm

| RPM200PD

(1 per box)

*Designed for large bony defects, including distal extension of the posterior ridge*

## PDMR (mandible right)

38 mm x 38 mm

| RPM200PDMR

(1 per box)

*Designed for large bony defects, including distal extension of the right posterior mandibular ridge*  
*NOTE: Non-perforated region is designed for lingual aspect*

## PDML (mandible left)

38 mm x 38 mm

| RPM200PDML

(1 per box)

*Designed for large bony defects, including distal extension of the left posterior mandibular ridge*  
*NOTE: Non-perforated region is designed for lingual aspect*

# Osteo-Mesh™ TM-300

Titanium nitride-coated mesh

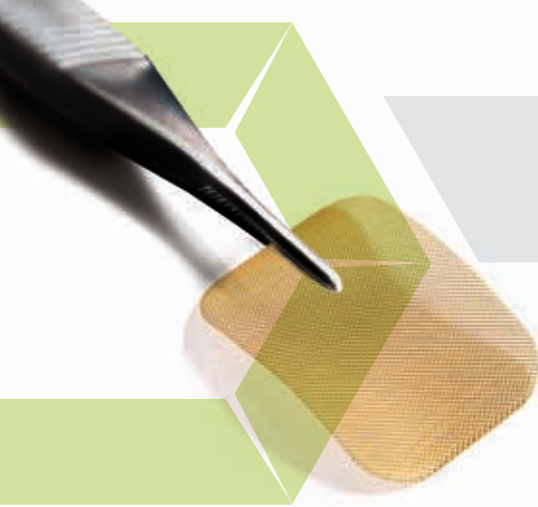

shown actual size

**25 mm x 34 mm**

(provided non-sterile)

| TM2534

(1 per box)



**45 mm x 45 mm**

(provided non-sterile)

| TM4545

(1 per box)



## ULTRA-THIN; 0.2 MM THICK

Easier to get primary closure

## 0.5 MM PORE SIZE

Contains most graft materials

## SAFE, HIGHLY INERT, NON-REACTIVE, NON-STICK NITRIDE COATING

- Improves tissue release upon removal
- High coating density with no pores to hold contaminants
- Will not stain or corrode
- Outstanding wear resistance

## REPEATEDLY STERILIZED BY AUTOCLAVE

Unused portions are not wasted



*Pore size of 0.5 mm contains graft material while allowing tissue ingrowth.*

# Cytoplast™ PTFE Suture

The soft monofilament suture



## 300 SERIES STAINLESS STEEL NEEDLES

All Cytoplast™ PTFE Sutures now have 300 series stainless steel needles, the gold standard material for suture needles. Tests comparing the new needles to previous needles show a substantial increase in needle strength, initial needle sharpness, and sustained needle sharpness. Tests show that the new 300 series needles are less likely to bend, require less force to penetrate, and maintain sharpness longer. Additionally, all silver needles now have longer and geometrically finer precision cutting edges. Data on file



All Cytoplast™ Sutures are 12 per box

**Now in NEW 28" lengths**

18" Undyed	Precision RC 19 mm	2/0 USP	CS0418
28" Undyed			CS0428
18" Undyed	Precision RC 16 mm	3/0 USP	CS0518
28" Undyed			CS0528
18" Undyed	Precision RC 19 mm	3/0 USP	CS051819
28" Undyed			CS052819
18" Undyed	RC 16 mm black needle	3/0 USP	CS0518BK
28" Undyed			CS0528BK
18" Undyed	RC 19 mm black needle	3/0 USP	CS051819BK
28" Undyed			CS052819BK
18" Undyed	TP 13 mm	4/0 USP	CS0618PERIO
28" Undyed			CS0628PERIO
18" Undyed	Precision RC 13 mm	4/0 USP	CS0618PREM
28" Undyed			CS0628PREM
18" Undyed	Precision RC 16 mm	4/0 USP	CS0618RC
28" Undyed			CS0628RC
18" Undyed	Precision RC 13 mm	5/0 USP	CS071813
28" Undyed			CS072813
18" Undyed	Precision RC 16 mm	5/0 USP	CS071816
28" Undyed			CS072816

## NEEDLE CODE DETAIL

RC 3/8 CIRCLE REVERSE CUTTING

TP 1/2 CIRCLE ROUND-BODIED



## 100% MEDICAL GRADE PTFE

Biologically inert

## MONOFILAMENT

Doesn't wick bacteria

## SOFT (NOT STIFF)

Comfortable for patients

## LITTLE TO NO PACKAGE MEMORY

Excellent handling, knots securely

## NON-RESORBABLE

Keeps the surgical site reliably closed

# Resorba® Glycolon™

Absorbable, Monofilament



<b>NEW</b> Violet	DSM 16 mm	3/0 USP	OD01204
<b>NEW</b> Violet	DSM 18 mm	3/0 USP	OD01205
Violet	HRT 18 mm	4/0 USP	OD01101
Violet	DSM 16 mm	4/0 USP	OD01201
Violet	DSM 18 mm	4/0 USP	OD01203
Violet	DSM 13 mm <b>black needle</b>	5/0 USP	OD01210
Violet	DSM 16 mm <b>black needle</b>	5/0 USP	OD01211
Violet	DSM 18 mm <b>black needle</b>	5/0 USP	OD01212
Violet	HRT 16 mm	5/0 USP	OD01100
Violet	DSM 16 mm	5/0 USP	OD01214
Undyed	DSM 18 mm	5/0 USP	OD01202
Undyed	DSM 13 mm	6/0 USP	OD01200
Violet	DSM 13 mm	6/0 USP	OD01213
<b>MICRO SUTURE:</b>			
Violet	HRT 10 mm	6/0 USP	OD01102

Glycolon™ is Resorba's® top selling suture material worldwide and is comprised of poly-glycolic acid (PGA) and polycaprolactone (PCL). The monofilament structure provides excellent handling properties, does not wick bacteria, and allows for atraumatic passage through the tissue. Glycolon™ maintains 50% of its tensile strength for 11-13 days. In Vivo data on file

"I like it so much that if I ask for a suture, **my staff doesn't need to ask what I want...they know it's 6-0 Glycolon™**. Can't beat that."

Israel Puterman, DMD, MSD  
Periodontist

"**Hands down my favorite resorbable sutures**; very easy to handle, **so clean on post ops**, also I love that it stays for a long time with good tensile strength. Last, but not least, it looks so beautiful in pictures."

Thaer Alqadoumi, DDS  
Periodontist

### NEEDLE CODE DETAIL

- DSM 3/8 CIRCLE PREMIUM REVERSE CUTTING
- HRT 1/2 CIRCLE ROUND-BODIED CUTTING



# Resorba<sup>®</sup> PGA Resorba<sup>™</sup>

Absorbable, Multifilament

PGA Resorba<sup>™</sup> is an absorbable suture made of precision-braided filaments of polyglycolic acid coated with a special resolactone coating to reduce surface friction when passing through tissue. The composition of PGA Resorba<sup>™</sup> ensures predictable and moderately rapid resorption in tissue. PGA Resorba<sup>™</sup> maintains 50% tensile strength for up to 21 days. In Vivo data on file



Violet	<b>HRT</b> 18 mm	4/0 USP	OD03100
Violet	<b>DSM</b> 18 mm	4/0 USP	OD03202
Violet	<b>HR</b> 17 mm	5/0 USP	OD03500
Violet	<b>DS</b> 18 mm	5/0 USP	OD03400
Violet	<b>DSM</b> 13 mm	5/0 USP	OD03201
Violet	<b>DSM</b> 13 mm	6/0 USP	OD03200

#### MICRO SUTURE:

Violet	<b>HRT</b> 10 mm	5/0 USP	OD03103
Violet	<b>HSM</b> 10 mm	5/0 USP	OD03700
Violet	<b>HSM</b> 10 mm	6/0 USP	OD03701
Violet	<b>DSM</b> 11 mm	6/0 USP	OD03203
Violet	<b>HRT</b> 10 mm	6/0 USP	OD03101
Violet	<b>DSM</b> 7 mm	7/0 USP	OD03206
Violet	<b>DSM</b> 11 mm	7/0 USP	OD03204

#### NEEDLE CODE DETAIL

**DSM** 3/8 CIRCLE PREMIUM REVERSE CUTTING



**DS** 3/8 CIRCLE STANDARD REVERSE CUTTING



**HRT** 1/2 CIRCLE ROUND-BODIED CUTTING



**HR** 1/2 CIRCLE ROUND-BODIED



**HSM** 1/2 CIRCLE PREMIUM REVERSE CUTTING



# Resorba® Resolon™

Non-Absorbable, Monofilament



*Resolon™ is initially like traditional nylon sutures until it undergoes a proprietary treatment process that results in a softer and more supple version of a nylon suture. Resolon™ provides clinicians a non-absorbable monofilament suture option that does not wick bacteria and has superior handling characteristics when compared to traditional nylon sutures.*

Blue	DSM 13 mm	4/0 USP	OD13202
Blue	DSM 16 mm	4/0 USP	OD13205
Blue	DSM 18 mm	4/0 USP	OD13207
Blue	DSM 16 mm black needle	4/0 USP	OD13215
Blue	HS 18 mm	5/0 USP	OD13700
Blue	DSM 13 mm	5/0 USP	OD13201
Blue	DSM 16 mm	5/0 USP	OD13204
Blue	DSM 18 mm	5/0 USP	OD13206
Blue	DSM 13 mm black needle	5/0 USP	OD13213
Blue	DSM 16 mm black needle	5/0 USP	OD13214
Blue	DSM 13 mm	6/0 USP	OD13200
Blue	DSM 16 mm	6/0 USP	OD13203
Blue	DSM 13 mm black needle	6/0 USP	OD13212
<b>MICRO SUTURE:</b>			
Blue	DSM 13 mm black needle	7/0 USP	OD13211

## NEEDLE CODE DETAIL

**DSM** 3/8 CIRCLE PREMIUM REVERSE CUTTING

**HS** 1/2 CIRCLE STANDARD REVERSE CUTTING



# Resorba® Resolon Twist™

Non-Absorbable, Pseudo-Monofilament

Resolon Twist™ is a pseudo-monofilament made of braided nylon fibers that are coated with a nylon sheath. The pseudo-monofilament design offers clinicians a non-absorbable suture that handles similarly to a multifilament suture but, due to its outer nylon coating, has the advantage of reduced drag when being pulled through soft tissue.



Undyed	<b>HRT</b> 18 mm	3/0 USP	<b>OD12100</b>
Undyed	<b>HS</b> 15 mm	4/0 USP	<b>OD12700</b>
Undyed	<b>DSM</b> 16 mm	4/0 USP	<b>OD12200</b>
Undyed	<b>DSM</b> 18 mm	4/0 USP	<b>OD12201</b>

## NEEDLE CODE DETAIL

**DSM** 3/8 CIRCLE PREMIUM REVERSE CUTTING



**HRT** 1/2 CIRCLE ROUND-BODIED CUTTING



**HS** 1/2 CIRCLE STANDARD REVERSE CUTTING





# Pro-Fix™ Membrane Fixation

Precision Fixation System

Tray and organizer dial are designed to store all Pro-fix™ components including up to 100 membrane fixation, tenting, and bone fixation screws. Blades are designed to work universally with all Pro-fix™ membrane fixation, tenting, and bone fixation screws.

*Pro-fix™ Membrane Fixation Screws are designed as an attractive alternative to using tacks for membrane stabilization. Easy pick-up, solid stability of the screw during transfer to the surgical site, and easy placement make membrane fixation fast and easy.*

## Membrane Fixation Kit

| PFMK20

Autoclavable Tecapro™ storage tray w/ screw organizer dial

Stainless steel driver handle

76 mm cruciform driver blade

56 mm cruciform driver blade

(20) 1.5 x 3 mm self-drilling membrane fixation screws

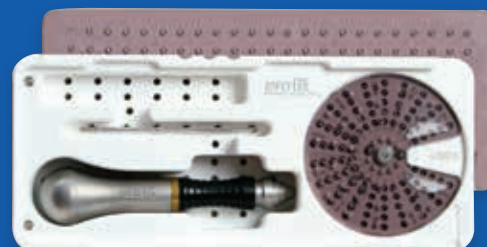

## Self-Drilling Membrane Fixation Screws

1.5 mm x 3 mm

| PFMF-5 (5 per box)

| PFMF-10 (10 per box)

| PFMF-20 (20 per box)



actual size

## Individual Components

Stainless Steel Driver Handle | PFDH

76 mm Cruciform Driver Blade | PFDB

56 mm Cruciform Driver Blade | PFDB56

24 mm Contra Angle Blade (10 mm exposed distal length) | PFDBCA

1.2 mm diam. Latch Type Pilot Drill | BI1001

Autoclavable Tecapro™ storage tray | PFT

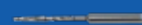



# Pro-Fix™ Tenting

Precision Fixation System

Pro-fix™ Tenting Screws are designed with a self-drilling tip, polished neck, and broader head to maintain space under resorbable and non-resorbable membranes in horizontal and vertical bone regeneration procedures.

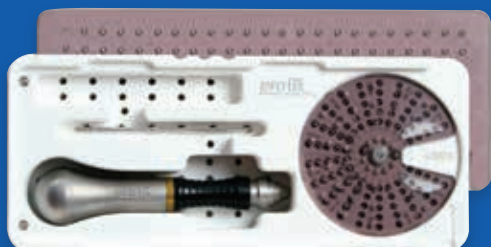

## Tenting Kit

| PFTK12

**\$997**

Autoclavable Tecapro™ storage tray w/ screw organizer dial

Stainless steel driver handle

76 mm cruciform driver blade

56 mm cruciform driver blade

(4) 1.5 x 3 mm self-drilling tenting screws (7 mm total length)

(4) 1.5 x 4 mm self-drilling tenting screws (8 mm total length)

(4) 1.5 x 5 mm self-drilling tenting screws (9 mm total length)

For individual Pro-Fix™ driver and container components, see opposite page.

## Self-Drilling Tenting Screws

1.5 mm x 3 mm polished neck

+ 4 mm threaded portion = 7 mm total



actual size

| PFT3 (1 per box)

| PFT3-5 (5 per box)

1.5 mm x 4 mm polished neck

+ 4 mm threaded portion = 8 mm total



actual size

| PFT4 (1 per box)

| PFT4-5 (5 per box)

1.5 mm x 5 mm polished neck

+ 4 mm threaded portion = 9 mm total



actual size

| PFT5 (1 per box)

| PFT5-5 (5 per box)

## Fully Threaded Self-Drilling Tenting Screws

1.5 mm x 8 mm



actual size

| PFT8 (1 per box)

1.5 mm x 10 mm



actual size

| PFT10 (1 per box)



# Pro-Fix™ Bone Fixation

Precision Fixation System

*Pro-fix™ Bone Fixation Screws are designed with finer pitched, self-tapping threads that give the screws greater clamping force while using less driver torque. The screws' threads are equipped with a cutting flute that allows for easier insertion into harder bone. The screws are placed into a 1.2 mm pre-drilled pilot hole.*

## Bone Fixation Kit

| PFBK12S

Autoclavable Tecapro™ storage tray w/ screw organizer dial

Stainless steel driver handle

76 mm cruciform driver blade

56 mm cruciform driver blade

1.2 mm diameter latch type pilot drill

(2) 1.5 x 8 mm bone fixation screws

(4) 1.5 x 10 mm bone fixation screws

(4) 1.5 x 12 mm bone fixation screws

(2) 1.5 x 14 mm bone fixation screws

*For individual Pro-Fix™ driver and container components, see page 32.*



## Self-Tapping Bone Fixation Screws

### 1.5 mm x 8 mm

| PFB8 (1 per box)

| PFB8-5 (5 per box)



actual size

### 1.5 mm x 10 mm

| PFB10 (1 per box)

| PFB10-5 (5 per box)



actual size

### 1.5 mm x 12 mm

| PFB12 (1 per box)

| PFB12-5 (5 per box)



actual size

### 1.5 mm x 14 mm

| PFB14 (1 per box)

| PFB14-5 (5 per box)



actual size

# Master-Pin-Control

Revolutionary hybrid pin system



## Master-Pin-Control

| BMP00

(34) Pins

Master-Pin-Tray

Screw Driver For Pin Removal

Fixation Holder

Initial Bur

Twist Drills: (2) 0.6 mm twist drills, (2) 0.8 mm twist drills



## Master-Pin-Control Basic

| BMPBA

(10) Pins

Master-Pin-Tray

Screw Driver For Pin Removal

Fixation Holder

Initial Bur

Twist Drills: (2) 0.6 mm twist drills, (2) 0.8 mm twist drills

## Master-Pin Longer Screw Driver

Designed to make pin removal easier in hard to reach areas



| MP15

(1 per box)

## Replacement Pins



| MP10

(10 per box)

| MP50

(50 per box)

| MP100

(100 per box)

## Decortication Bur

1.2 mm diameter x 4.0 mm long decortication bur with drill stop



| 2035-012-RA

(2 per box)

The Master-Pin-Control Bone Management® system is used for the fixation of membranes (absorbable and non-absorbable) in order to avoid micro-mobility of the graft. The pins have an extremely sharp tip that allows precise placement into cortical bone. Mini-threads on the pins make them a hybrid of a screw and pin. The threads on the pins increase the surface area of the shaft, resulting in pin stability, while also making removal of the pins possible with the included screwdriver.

**NEW**

# Master-Mill & Master-Core System

*Meisinger*  
since  
**1888**

## Master-Mill

| BKM00



## Master-Core Professional

| BMCPR (20 Trephines)



## Master-Core-Basic

| BMCBA (10 Trephines)



*The Master-Core System contains trephines with selected lengths and diameters for a safe and simple extraction of bone cylinders. The different trephines included in the system have diameters of 3.0 mm, 5.0 mm, and 7.0 mm and are 3.0 mm to 8.0 mm in length. The trephines are equipped with automatic depth stops, which offer maximum safety and flexibility while saving anatomical structures. Due to the black coating and depth markings on the working parts the user can work without glare.*

“The Swann-Morton® blades have several advantages: First they cut, and **they cut clean and easy**. Secondly, **their shape is perfect**. The 15c is like a microsurgical blade, cutting precisely with its spiky tip. The 15 blade has a long, perfectly angulated blade that can be used very safely for eliminating periosteal bundles around the nerve. I use the 15 blade for this and for cutting through the periosteum on the third zone of the lingual flap.”

*Istvan Urban, DMD, MD, PhD*  
Periodontist  
Oral and Maxillofacial Surgeon

#### SWANN-MORTON® BLADE EDGE DESIGN

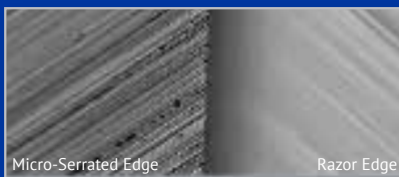

*Unique cutting-edge design delivers a consistently sharp blade.*

#### COMPETITOR BLADE EDGE DESIGN



*While initially sharp, this edge can deteriorate faster.*



#### 15 Blade

- | 01SM15 Stainless Steel (100 per box)
- | 00SM15 Carbon Steel (100 per box)



#### 15C Blade

- | 01SM15C Stainless Steel (100 per box)
- | 00SM15C Carbon Steel (100 per box)



#### 12D Blade

- | 01SM12D Stainless Steel (100 per box)
- | 00SM12D Carbon Steel (100 per box)

## SMOOTH RAZOR EDGE SUPPORTED BY A MICRO-SERRATED EDGE

Maintains a consistently sharp blade

## EDGE DESIGN DELIVERS A TACTILE SENSITIVITY

Improves depth control while providing equal, smooth tissue margins

## Micross

Minimally invasive cortical bone collector



Holds up to 0.25 cc at a time

| 4049 (1 sterile scraper per package)

### APPLICATIONS

- Extraction defects
- Periodontal defects
- Sinus lift procedures

### HARVESTING SITES

- Oblique external line with tunnel
- Lingual bone
- Sinus window
- Palate
- Zygomatic area with tunnel
- Small areas near the defect



*The cannula's 5 mm external diameter allows the Micross to be easily inserted into tissue tunnels.*

## Smartscraper

Cortical bone collector and syringe in one



Holds up to 0.3 cc at a time

| 4890 (3 sterile scrapers per package)

### APPLICATIONS

- Extraction defects
- Periodontal defects
- Sinus lift procedures
- Ridge augmentation

### HARVESTING SITES

- Oblique external line with tunnel
- Ramus
- Mandibular symphysis
- Sinus window
- Lingual bone
- Zygomatic area
- Nasal spine
- Palate
- Small areas near the defect



*The Smartscraper is opened with a simple movement. The syringe, in which the bone particulate has been collected, can then be used to place graft directly into areas with limited access.*

# Safescraper® Twist - Curve

Versatile cortical bone collector

A 160° blade allows clinicians to collect bone from any bony surface.



The Safescraper® Twist's transparent chamber holds up to 2.5 cc of bone that can be used alone or mixed in combination with other graft materials.

not actual size



Holds up to 2.5 cc at a time

| 3987 (3 sterile scrapers per package)

## APPLICATIONS

- Extraction defects
- Periodontal defects
- Sinus lift procedures
- Ridge augmentation

## HARVESTING SITES

- Oblique external line with tunnel
- Ramus
- Mandibular symphysis
- Sinus window
- Lingual bone
- Zygomatic area
- Nasal spine
- Palate
- Small areas near the defect

# Safescraper® Twist - Curve Volumizer

Versatile cortical bone collector

**NEW**

Double grooves on the blade allow for three collecting surfaces.



The Volumizer offers the same performance while collecting a larger volume of autologous cortical bone.

not actual size



Holds up to 2.5 cc at a time

| 5501 (3 sterile scrapers per package)

# Selection of Applicable References

## MEMBRANES

- Antonious M, Couso-Queiruga E, Barwacz C, Gonzalez-Martin O, Avila-Ortiz G. Evaluation of a Minimally Invasive Alveolar Ridge Reconstruction Approach in Postextraction Dehiscence Defects: A Case Series. *Int J Periodontics Restorative Dent.* 2021 May-Jun;41(3):335-345.
- Al Hugail AM, Mealey BL, Walker C, Al Harthi S, Duong M, Noujeim M, Lasho DJ, Prihoda TJ, Huynh-Ba G. Evaluation of healing at molar extraction sites with ridge preservation using a non-resorbable dense polytetrafluoroethylene membrane: A four-arm cohort prospective study. *Clin Exp Dent Res.* 2021 Jun 6. Epub ahead of print.
- Maiorana MC, Fontana F, Dal Polo MR, Pieroni S, Ferrantino L, Poli PP, Simion M. Dense Polytetrafluoroethylene Membrane versus Titanium Mesh in Vertical Ridge Augmentation: Clinical and Histological Results of a Split-mouth Prospective Study. *J Contemp Dent Pract* 2021; 22 (5):465-472.
- Urban IA, Barootchi S, Tavelli L, Wang HL. Inter-Implant Papilla Reconstruction via a Bone and Soft Tissue Augmentation: A Case Report with a Long-Term Follow-up. *Int J Periodontics Restorative Dent.* 2021 Nov-Dec;41(2):169-175.
- Amaral Valladao CA JR, Freitas Monteiro M, Joly JC. Guided bone regeneration in staged vertical and horizontal bone augmentation using platelet-rich fibrin associated with bone grafts: a retrospective clinical study. *Int J Implant Dent.* 2020 Oct 17;6(1):72.
- Nelson AC, Mealey BL. A randomized controlled trial on the impact of healing time on wound healing following ridge preservation using a 70%/30% combination of mineralized and demineralized freeze-dried bone allograft. *J Periodontol.* 2020 Oct;91(10):1256-1263.
- Pistilli R, Simion M, Barausse C, Gasparro R, Pistilli V, Bellini P, Felice P. Guided Bone Regeneration with Non-resorbable Membranes in the Rehabilitation of Partially Edentulous Atrophic Arches: A Retrospective Study on 122 Implants with a 3- to 7-Year Follow-up. *Int J Periodontics Restorative Dent.* Sep/Oct 2020;40(5):685-692.
- Windisch P, Orban K, Salvi Ge, Sculean A, Molnar B. Vertical-guided bone regeneration with a titanium-reinforced d-PTFE membrane utilizing a novel split-thickness flap design: a prospective case series. *Clin Oral Investig.* 2020 Oct 10. <Epub ahead of print>
- Cucchi A, Vignudelli E, Fiorino A, Pellegrino G, Corinaldesi G. Vertical ridge augmentation (VRA) with Ti-reinforced d-PTFE membranes or Ti meshes and collagen membranes: 1-year results of a randomized clinical trial. *Clin Oral Implants Res.* 2020 Oct 5. <Epub ahead of print>
- Avila-Ortiz G, Gubler M, Romero-Bustillos M, Nicholas CL, Zimmerman MB, Barwacz CA. Efficacy of Alveolar Ridge Preservation: A Randomized Controlled Trial. *J Dent Res.* 2020 Feb 12:22034520905660.
- Wen SC, Barootchi S, Huang WX, Wang HL. Time analysis of alveolar ridge preservation using a combination of mineralized bone-plug and dense-polytetrafluoroethylene membrane: A histomorphometric study. *J Periodontol.* 2020 Feb;91(2):215-222.
- Ibraheem AG, Blanchard SB. Alveolar Ridge Augmentation Around Exposed Mandibular Dental Implant with Histomorphometric Analysis. *Clin Adv Periodontics.* 2020 Jan 22.
- Koidou VP, Chatzopoulos GS, Johnson D. The "Combo Technique": A Case Series Introducing the Use of a d-PTFE Membrane in Immediate Postextraction Guided Bone Regeneration. *J Oral Implantol.* 2019 Dec;45(6):486-493.
- Wen SC, Huang WX, Wang HL. Regeneration of Peri-implantitis Infrabony Defects: Report on Three Cases. *Int J Periodontics Restorative Dent.* 2019 Sep/Oct;39(5):615-621.
- Mazor Z, Horowitz RA, Prasad H, Kotsakis GA. Healing Dynamics Following Alveolar Ridge Preservation with Autologous Tooth Structure. *Int J Periodontics Restorative Dent.* 2019 Sep/Oct;39(5):697-702.
- Nguyen V, Von Krockow N, Pouchet J, Weigl PM. Periosteal Inhibition Technique for Alveolar Ridge Preservation as It Applies to Implant Therapy. *Int J Periodontics Restorative Dent.* 2019 Sep/Oct;39(5):737-744.
- Sabe-Alarab M, Al-Essa H, Jaber F, Shomal Y, Kharfan J. Alveolar ridge preservation with d-ptfe membrane a randomized controlled trial. *Int J Recent Sci Res.* 10(09), pp.34658-34664.
- Cucchi A, Sartori M, Aldini NN, Vignudelli E, Corinaldesi G. A Proposal of Pseudo-periosteum Classification After GBR by Means of Titanium-Reinforced d-PTFE Membranes or Titanium Meshes Plus Cross-Linked Collagen Membranes. *Int J Periodontics Restorative Dent.* 2019 Jul/Aug;39(4):e157-e165.
- Faciola Pessôa De Oliveira PG, Pedroso Bergamo ET, Bordin D, Arbex L, Konrad D, Gil LF, Neiva R, Tovar N, Witek L, Coelho PG. Ridge Architecture Preservation Following Minimally Traumatic Exodontia Techniques and Guided Tissue Regeneration. *Implant Dent.* 2019 Aug;28(4):319-328.
- Gallo P, Díaz-Báez D. Management Of 80 Complications In Vertical And Horizontal Ridge Augmentation With Nonresorbable Membrane (d-PTFE): A Cross-Sectional Study. *Int J Oral Maxillofac Implants.* 2019 July/August;34(4):927-935.
- Urban I, Montero E, Monje A, Sanz-Sanchez I. Effectiveness of vertical ridge augmentation interventions: A systematic review and meta-analysis. *J Clin Periodontol.* 2019 Jun;46 Suppl 21:319-339.
- Cheng A, Berridge J, McGary R, Erley K, Johnson T. The Extraction Socket Management Continuum: A Hierarchical Approach to Dental Implant Site Development. *Clinical Advances in Periodontics, Vol. 9, No. 2, June 2019.*
- Urban I, Montero E, Monje A, Sanz-Sánchez I. Effectiveness of vertical ridge augmentation interventions: A systematic review and meta-analysis. *J Clin Periodontol.* 2019 Jun;46 Suppl 21:319-339.
- Phillips DJ, Swenson DT, Johnson TM. Buccal bone thickness adjacent to virtual dental implants following guided bone regeneration. *J Periodontol.* 2019 Jun;90(6):595-607.
- Altıparmak N, Akdeniz SS. Primary closure versus open membrane technique in augmentation of deficient alveolar ridges. *Int J Oral Maxillofac Surg., Vol. 48, Supplement 1, 43, May 01, 2019.*
- Mertens C, Braun S, Krisam J, Hoffmann J. The influence of wound closure on graft stability: An in vitro comparison of different bone grafting techniques for the treatment of one-wall horizontal bone defects. *Clin Implant Dent Relat Res.* 2019 Apr;21(2):284-291.
- Wu IH, Bakhshalian N, Galaustian R, Naini RB, Min S, Freire M, Zadeh HH. Retrospective Analysis of the Outcome of Ridge Preservation with Anorganic Bovine Bone Mineral: Marginal Bone Level at Implants Placed Following Healing of Grafted Extraction Sockets. *Int J Periodontics Restorative Dent.* 2019 Jan/Feb;39(1):131-140.
- Phillips DJ, Swenson DT, Johnson TM. Buccal bone thickness adjacent to virtual dental implants following guided bone regeneration. *J Periodontol.* 2018 Dec 21.. [Epub ahead of print]
- Mendoza-Azpur G, Gallo P, Mayta-Tovalino F, Alva R, Valdivia E. A Case Series of Vertical Ridge Augmentation Using a Nonresorbable Membrane: A Multicenter Study. *Int J Periodontics Restorative Dent.* 2018 Nov/Dec;38(6):811-816.
- Sun DJ, Lim HC, Lee DW. Alveolar ridge preservation using an open membrane approach for sockets with bone deficiency: A randomized controlled clinical trial. *Clin Implant Dent Relat Res.* 2018 Nov 5.[Epub ahead of print]
- Changi KK, Greenstein G. Cytocone Procedure: Conserva-



# Selection of Applicable References

- tive Repair of a Buccal Plate Dehiscence in Preparation for Implant Placement. *Compend Contin Educ Dent*. 2018 May;39(5):294-299.
- Plonka AB, Urban IA, Wang HL. Decision Tree for Vertical Ridge Augmentation. *Int J Periodontics Restorative Dent*. 2018 Mar/Apr;38(2):269-275.
  - Johnson M, Baron D. Tunnel Access for Guided Bone Regeneration in the Maxillary Anterior. *Clinical Advances in Periodontics*. Vol 8. No 1. March 2018.
  - Bakhshalian N, Freire M, Min S, Wu I, Zadeh HH. Retrospective Analysis of the Outcome of Ridge Preservation with Anorganic Bovine Bone Minerals: Microcomputed Tomographic Assessment of Wound Healing in Grafted Extraction Sockets. *Int J Periodontics Restorative Dent*. 2018 Jan/Feb;38(1):103-111.
  - Urban I, Traxler H, Romero-Bustillos M, Farkasdi S, Bartee B, Baksa G, Avila-Ortiz G. Effectiveness of Two Different Lingual Flap Advancing Techniques for Vertical Bone Augmentation in the Posterior Mandible: A Comparative, Split-Mouth Cadaver Study. *Int J Periodontics Restorative Dent*. 2018 Jan/Feb;38(1):35-40.
  - Johnson TM, Berridge JP, Baron D. Protocol for Maintaining Alveolar Ridge Volume in Molar Immediate Implant Sites. *Clinical Advances in Periodontics*. November 2017, Vol. 7, No. 4, Pages 207-214
  - Pistilli R, Checchi V, Sammartino G, Simion M, Felice P. Safe New Approach to the Lingual Flap Management in Mandibular Augmentation Procedures: The Digitoclastic Technique. *Implant Dent*. 2017 Oct;26(5):790-795.
  - Urban IA, Monje A, Lozada J, Wang HL. Principles for Vertical Ridge Augmentation in the Atrophic Posterior Mandible: A Technical Review. *Int J Periodontics Restorative Dent*. 2017 Sep/Oct;37(5):639-645.
  - Cucchi A, Vignudelli E, Napolitano A, Marchetti C, Corinaldesi G. Evaluation of complication rates and vertical bone gain after guided bone regeneration with non-resorbable membranes versus titanium meshes and resorbable membranes. A randomized clinical trial. *Clin Implant Dent Relat Res*. 2017 Jul 26. (epub ahead of print).
  - Gultekin BA, Cansiz E, Borahan MO. Clinical and 3-Dimensional Radiographic Evaluation of Autogenous Iliac Block Bone Grafting and Guided Bone Regeneration in Patients With Atrophic Maxilla. *J Oral Maxillofac Surg*. 2017 Apr;75(4):709-722.
  - Ghensi P, Stablum W, Bettio E, Soldini MC, Tripi TR, Soldini C. Management of the exposure of a dense PTFE (d-PTFE) membrane in guided bone regeneration (GBR): a case report. *Oral Implantol (Rome)*. 2017 Nov 30;10(3):335-342.
  - Laurito D, Lollobrigida M, Gianni F, Bosco S, Lamazza L, De Biase A. Alveolar Ridge Preservation with nc-HA and d-PTFE Membrane: A Clinical, Histologic, and Histomorphometric Study. *Int J Periodontics Restorative Dent*. 2017 Mar/Apr;37(2):283-290.
  - Walker CJ, Prihoda TJ, Mealey BL, Lasho DJ, Noujeim M, Huynh-Ba G. Evaluation of healing at molar extraction sites with and without ridge preservation: a randomized controlled clinical trial. *J Periodontol*. 2017 Mar;88(3):241-249.
  - Laurito D, Cugnetto R, Lollobrigida M, Guerra F, Vestri A, Gianni F, Bosco S, Lamazza L, De Biase A. Socket Preservation with d-PTFE Membrane: Histologic Analysis of the Newly Formed Matrix at Membrane Removal. *Int J Periodontics Restorative Dent*. 2016 Nov/Dec;36(6):877-883.
  - Ronda M, Stacchi C. A Novel Approach for the Coronal Advancement of the Buccal Flap. *Int J Periodontics Restorative Dent*. 2015 Nov-Dec;35(6):795-801.
  - Urban IA, Monje A, Wang HL. Vertical Ridge Augmentation and Soft Tissue Reconstruction of the Anterior Atrophic Maxillae: A Case Series. *Int J Periodontics Restorative Dent*. 2015 Sep/Oct;35(5):613-23.
  - Al-Hezaimi K, Iezzi G, Rudek I, Al-Daafas A, Al-Hamdan K, Al-Rasheed A, Javed F, Piattelli A, Wang HL. Histomorphometric Analysis of Bone Regeneration Using a Dual Layer of Membranes (dPTFE Placed Over Collagen) in Fresh Extraction Sites: A Canine Model. *J Oral Implantol*. 2015 Apr;41(2):188-95.
  - Borg TD, Mealey BL. Histologic healing following tooth extraction with ridge preservation using mineralized versus combined mineralized-demineralized freeze-dried bone allograft: a randomized controlled clinical trial. *J Periodontol*. 2015 Mar;86(3):348-55.
  - Cucchi A, Ghensi P. Vertical Guided Bone Regeneration using Titanium-reinforced d-PTFE Membrane and Prehydrated Corticocancellous Bone Graft. *Open Dent J*. 2014 Nov 14;8:194-200.
  - Ronda M, Rebaudi A, Torelli L, Stacchi C. Expanded vs. dense polytetrafluoroethylene membranes in vertical ridge augmentation around dental implants: a prospective randomized controlled clinical trial. *Clin Oral Implants Res*. 2014 Jul;25(7):859-66.
  - Barboza EP, Stutz B, Mandarino D, Rodrigues DM, Ferreira VF. Evaluation of a dense polytetrafluoroethylene membrane to increase keratinized tissue: a randomized controlled clinical trial. *Implant Dent*. 2014 Jun;23(3):289-94.
  - Urban IA, Lozada JL, Jovanovic SA, Nagursky H, Nagy K. Vertical Ridge Augmentation with Titanium-Reinforced, Dense-PTFE Membranes and a Combination of Particulated Autogenous Bone and Anorganic Bovine Bone-Derived Mineral: A Prospective Case Series in 19 Patients. *Int J Oral Maxillofac Implants*. 2014 Jan-Feb;29(1):185-93.
  - Carbonell JM, Martin IS, Santos A, Pujol A, Sanz-Molina JD, Nart J. High-density polytetrafluoroethylene membranes in guided bone and tissue regeneration procedures: a literature review. *Int J Oral Maxillofac Surg*. 2014 Jan;43(1):75-84.
  - Vittorini Orgeas G, Clementini M, De Risi V, de Sanctis M. Surgical techniques for alveolar socket preservation: a systematic review. *Int J Oral Maxillofac Implants*. 2013 Jul-Aug;28(4):1049-61.
  - Al-Hezaimi K, Rudek I, Al-Hamdan KS, Javed F, Nooh N, Wang HL. Efficacy of using a dual layer of membrane (dPTFE placed over collagen) for ridge preservation in fresh extraction sites: a micro-computed tomographic study in dogs. *Clin Oral Implants Res*. 2013 Oct;24(10):1152-7.
  - Waasdorp J, Feldman S. Bone regeneration around immediate implants utilizing a dense polytetrafluoroethylene membrane without primary closure: A report of 3 cases. *J Oral Implantol*. 2013;39:355-361.
  - Annibaldi S, Bignozzi I, Sammartino G, La Monaca G, Cristalli MP. Horizontal and Vertical Ridge Augmentation in Localized Alveolar Deficient Sites: A Retrospective Case Series. *Implant Dent*. 2012 Jun;21(3):175-185.
  - Levin B. Immediate temporization of immediate implants in the esthetic zone: Evaluating survival and bone maintenance. *Compendium* 2011;32:52-62.
  - Barboza EP, Stutz B, Ferreira VF, Carvalho W. Guided bone regeneration using nonexpanded polytetrafluoroethylene membranes in preparation for dental implant placements – A report of 420 cases. *Implant Dent*. 2010;19:2-7.
  - Zafiropoulos GG, Deli G, Bartee BK, Hoffman O. Single-tooth implant placement and loading in fresh and regenerated extraction sockets. Five-year results: A case series using two different implant designs. *J Periodontol*. 2010;81:604-615.
  - Zafiropoulos GG, Hoffmann O, Kasaj A, Willershausen B, Deli G, Tatakis DN. Mandibular molar root resection versus implant therapy: A retrospective nonrandomized study. *J Oral Implantol*. 2009;35:52-62.

# Selection of Applicable References

- Fotek PD, Neiva RF, Wang HL. Comparison of dermal matrix and polytetrafluoroethylene membrane for socket bone augmentation: A clinical and histologic study. *J Periodontol*. 2009;80:776-785.

- Hoffman O, Bartee BK, Beaumont C, Kasaj A, Deli G, Zafiroopoulos GG. Alveolar bone preservation in extraction sockets using non-resorbable dPTFE membranes: A retrospective non-randomized study. *J Periodontol*. 2008;79:1355-1369.

- Barber HD, Lignelli J, Smith BM, Bartee BK. Using a dense PTFE membrane without primary closure to achieve bone and tissue regeneration. *J Oral Maxillofac Surg*. 2007;65:748-752.

- Walters SP, Greenwell H, Hill M, Drisko C, Pickman K, Scheetz JP. Comparison of porous and non-porous teflon membranes plus a xenograft in the treatment of vertical osseous defects: A clinical reentry study. *J Periodontol*. 2003;74:1161-1168.

- Bartee BK. Extraction site reconstruction for alveolar ridge preservation. Part 1: Rationale and material selection. *J Oral Implantol*. 2001;27:187-193.

- Bartee BK. Extraction site reconstruction for alveolar ridge preservation. Part 2: Membrane-assisted surgical technique. *J Oral Implantol*. 2001;27:194-197.

- Lamb JW III, Greenwell H, Drisko C, Henderson RD, Scheetz JP, Rebitski G. A comparison of porous and non-porous teflon membranes plus demineralized freeze-dried bone allograft in the treatment of class II buccal/lingual furcation defects: A clinical reentry study. *J Periodontol*. 2001;72:1580-1587.

- Bartee BK. Evaluation of a new polytetrafluoroethylene guided tissue regeneration membrane in healing extraction sites. *Compend Contin Educ Dent* 1998;19:1256-1264.

- Bartee BK, Carr JA. Evaluation of a high-density polytetrafluoroethylene (n-PTFE) membrane as a barrier material to facilitate guided bone regeneration in the rat mandible. *J Oral Implantol*. 1995;21:88-95.

- Bartee BK. The use of high-density polytetrafluoroethylene membrane to treat osseous defects: Clinical reports. *Implant Dent*. 1995;4:21-26.

## ZMATRIX™

- Cadenas-Vacas G, Martínez-Rodríguez N, Barona-Dorado C, Sánchez-Labrador L, Cortés-Bretón Brinkmann J, Meniz-García C, et al. Calcium phosphate modified with silicon vs. Bovine hydroxyapatite for alveolar ridge preservation: densitometric evaluation, morphological changes and

histomorphometric study. *Materials (Basel)* [Internet]. 2021;14(4): 940.

- Bruyckere T de, Cosyn J, Younes F, Hellyn J, Bekx J, Cleymaet R, et al. A randomized controlled study comparing guided bone regeneration with connective tissue graft to reestablish buccal convexity: One-year aesthetic and patient-reported outcomes. *Clin Oral Implants Res*. 2020;31(6): 507-16.

- Redemagni M, Mascetti T, Garlini G. Post-extractive immediate implant placement and immediate provisionalization at sites requiring buccal bone regeneration. *EC Dental Science*. 2019;18(6): 1207-16.

- Raz P, Brosh T, Ronen G, Tal H. Tensile properties of three selected collagen membranes. *Biomed Res Int*. 2019 Dec 5;2019:5163603.

- Sanz-Sanchez I, Wessing B, Polizzi G, et al. Randomized clinical trial comparing two resorbable collagen membranes demonstrates good bone formation and soft tissue healing with GBR at single implant sites with dehiscence defects. *J Clin Periodontol* 2018;45(S19):19-20 [oral presentation].

- Omar O, Dahlin A, Gasser A, et al. Tissue dynamics and regenerative outcome in two resorbable noncross-linked collagen membranes for guided bone regeneration: A preclinical molecular and histological study in vivo. *Clin Oral Impl Res*; 2018;29(1):7-19.

- Wessing B, Urban I, Montero E, et al. A multicenter randomized controlled clinical trial using a new resorbable non-cross-linked collagen membrane for guided bone regeneration at dehiscence single implant sites: interim results of a bone augmentation procedure. *Clin Oral Impl Res*; 2017;28(11):e218-e226.

- Jiménez García J, Bergehezan S, Caramés JMM, Dard MM, Marques DNS. Effect of cross-linked vs non-cross-linked collagen membranes on bone: A systematic review. *J Periodontol*. Res. 2017;1-10.

- Wessing B, Emmerich M, Bozkurt A. Horizontal ridge augmentation with a novel resorbable collagen membrane: a retrospective analysis of 36 consecutive patients. *Int J Periodontics Restorative Dent* 2016;36(2):179-187.

- Gasser A, Wessing B, Eummelen L, et al. Mechanical stability of collagen membranes: an in vitro study. *J Dent Res* 2016;95(Spec Iss A): 1683.

- Bozkurt A, Apel C, Sellhaus B, et al. Differences in degradation behavior of two non-cross-linked collagen barrier membranes: an in vitro and in vivo study. *Clin Oral Impl Res*; 2014; 25(12):1403-1411.

- Jäger M, Degistirici O, Knipper A, Fischer J, Sager M, Krauspe R. Bone healing and migration of cord blood-derived stem cells into a critical size femoral defect after xenotransplantation. *J Bone Miner Res*. 2007;22(8): 1224-33.

## RIDGE AUGMENTATION MESH

- Urban IA, Saleh MHA, Ravidá A, Forster A, Wang HL, Barath Z. Vertical bone augmentation utilizing a titanium-reinforced PTFE mesh: A multi-variate analysis of influencing factors. *Clin Oral Implants Res*. 2021 Mar 31. Epub ahead of print.

- Urban I, Montero E, Monje A, Sanz-Sanchez I. Effectiveness of vertical ridge augmentation interventions: A systematic review and meta-analysis. *J Clin Periodontol*. 2019 Jun;46 Suppl 21:319-339.

## COMBINATION ALLOGRAFT

- Antonious M, Couso-Queiruga E, Barwacz C, Gonzalez-Martin O, Avila-Ortiz G. Evaluation of a Minimally Invasive Alveolar Ridge Reconstruction Approach in Postextraction Dehiscence Defects: A Case Series. *Int J Periodontics Restorative Dent*. 2021 May-Jun;41(3):335-345.

- Nelson AC, Mealey BL. A randomized controlled trial on the impact of healing time on wound healing following ridge preservation using a 70%/30% combination of mineralized and demineralized freeze-dried bone allograft. *J Periodontol*. 2020 Oct;91(10):1256-1263.

- Cucchi A, Sartori M, Aldinia NN, Vignudelli E, Corinaldesi G. A Proposal of Pseudo-periosteum Classification After GBR by Means of Titanium-Reinforced d-PTFE Membranes or Titanium Meshes Plus Cross-Linked Collagen Membranes. *Int J Periodontics Restorative Dent*. 2019 Jul/Aug;39(4):e157-e165.

- Demetter RS, Calahan BG, Mealey BL. Histologic Evaluation of Wound Healing After Ridge Preservation With Cortical, Cancellous, and Combined Cortico-Cancellous Freeze-Dried Bone Allograft: A Randomized Controlled Clinical Trial. *J Periodontol*. 2017 Sep;88(9):860-868.

- Chan HL, Benavides E, Tsai CY, Wang HL. A Titanium Mesh and Particulate Allograft for Vertical Ridge Augmentation in the Posterior Mandible: A Pilot Study. *Int J Periodontics Restorative Dent*. 2015 Jul-Aug;35(4):515-22.

- Borg TD, Mealey BL. Histologic healing following tooth extraction with ridge preservation using mineralized versus combined mineralized-demineralized freeze-dried bone allograft: a randomized controlled clinical trial. *J Periodontol*. 2015 Mar;86(3):348-55.

# Selection of Applicable References

## XENOGRAFT

- Lai WJ, Michalek JE, Liu Q, Mealey BL. Ridge preservation following tooth extraction using bovine xenograft compared with porcine xenograft: A randomized controlled clinical trial. *J Periodontol*. 2020 Mar;91(3):361-368.

## SUTURE

- Taysi AE, Ercal P, Sismanoglu S. Comparison between tensile characteristics of various suture materials with two suture techniques: an in vitro study. *Clin Oral Invest*. 2021 Apr 14.

- Abellán D, Nart J, Pascual A, Cohen RE, Sanz-Moliner JD. Physical and Mechanical Evaluation of Five Suture Materials on Three Knot Configurations: An in Vitro Study. *Polymers*. 2016; 8(4):147

- Silverstein LH, Kurtzman GM, Shatz PC. Suturing for optimal soft-tissue management. *J Oral Implantol*. 2009;35:82-90.

- Silverstein LH. Suturing principles: Preserving needle edges during dental suturing. *PPAD*. 2005;17:562-564.

## BONE SCRAPERS

- Bacci C, Lucchiari N, Valente M, Della Barbera M, Frigo AC, Berengo M. Intra-oral bone harvesting: two methods compared using histological and histomorphometric assessments. *Clin Oral Implants Res*. 2011 Jun;22(6):600-5.

- Caubet J, Petzold C, Sáez-Torres C, Morey M, Iriarte JJ, Sánchez J, Torres JJ, Ramis JM, Monjo M. Sinus graft with safescraper: 5-year results. *J Oral Maxillofac Surg*. 2011 Feb;69(2):482-90.

- Trombelli L, Farina R, Marzola A, Itró A, Calura G. GBR and autogenous cortical bone particulate by bone scraper for alveolar ridge augmentation: A 2 case report. *Int J Oral Maxillofac Implants*. 2008;23:111-116.

- Zaffe D, D'Avenia F. A novel bone scraper for intraoral harvesting: A device for filling small bone defects. *Clin Oral Implants Res*. 2007;18:525-533.

- Trombelli L, Annunziata M, Belardo S, Farina R, Scabbia A, Guida L. Autogenous bone graft in conjunction with enamel matrix derivative in the treatment of deep periodontal intra-osseous defects: A report of 13 consecutively treated patients. *J Clin Periodontol*. 2006;33:69-75.

## NOVABONE®

- Bhandari S, Thomas R, Kumar T, Shah R, Mehta DS. Maxillary Sinus Augmentation Using Hydraulic Pressure by Lateral Approach and Simultaneous Implant Placement: Clinicoradiographic Study. *Implant Dent*. 2019 Oct;28(5):514-519.

- Bodhare GH, Kolte AP, Kolte RA, Shirke PY. Clinical and radiographic evaluation and comparison of bioactive bone alloplast morsels when used alone and in combination with platelet-rich fibrin in the treatment of periodontal intrabony defects-A randomized controlled trial. *J Periodontol*. 2019 Jun;90(6):584-594.

- Mahesh L, Venkataraman N, Shukla S, Prasad H, Kotsakis GA. Alveolar ridge preservation with the socket-plug technique utilizing an alloplastic putty bone substitute or a particulate xenograft: a histological pilot study. *J Oral Implantol*. 2015 Apr;41(2):178-83.

- Kotsakis GA, Mazor Z. A simplified approach to the minimally invasive antral membrane elevation technique utilizing a viscoelastic medium for hydraulic sinus floor elevation. *Oral Maxillofac Surg*. 2015 Mar;19(1):97-101.

- Ioannou AL, Kotsakis GA, Kumar T, Hinrichs JE, Romanos G. Evaluation of the bone regeneration potential of bioactive glass in implant site development surgeries: a systematic review of the literature. *Clin Oral Investig*. 2015 Mar;19(2):181-91.

- Babbush CA, Kanawati A. Clinical evaluation of 262 osseointegrated implants placed in sites grafted with calcium phosphosilicate putty: a retrospective study. *J Oral Implantol*. 2015 Feb;41(1):63-9.

- Kotsakis GA, Joachim FP, Saroff SA, Mahesh L, Prasad H, Rohrer MD. Histomorphometric evaluation of a calcium-phosphosilicate putty bone substitute in extraction sockets. *Int J Periodontics Restorative Dent*. 2014 Mar-Apr;34(2):233-9.

- Kher U, Mazor Z, Stanitsas P, Kotsakis GA. Implants placed simultaneously with lateral window sinus augmentation using a putty alloplastic bone substitute for increased primary implant stability: a retrospective study. *Implant Dent*. 2014 Aug;23(4):496-501.

- Kotsakis GA, Salama M, Chrepa V, Hinrichs JE, Gaillard P. A randomized, blinded, controlled clinical study of particulate anorganic bovine bone mineral and calcium phosphosilicate putty bone substitutes for socket preservation. *Int J Oral Maxillofac Implants*. 2014 Jan-Feb;29(1):141-51.

- Jodia K, Sadhwani BS, Parmar BS, Anchlía S, Sadhwani SB. Sinus elevation with an alloplastic material and simultaneous implant placement: a 1-stage procedure in severely atrophic maxillae. *J Maxillofac Oral Surg*. 2014 Sep;13(3):271-80.

- Kim DM, Nevins M, Camelo M, Nevins ML, Schupbach P, Rodrigues VS, Fiorellini JP. Human histologic evaluation of the use of the dental putty for bone formation in the maxillary sinus: case series. *J Oral Implantol*. 2012 Aug;38(4):391-8.

- Lanka M, Salama M, Kurtzman, Gregori. Socket grafting with calcium phosphosilicate alloplast putty: a histomorphometric evaluation. *Compend Contin Educ Dent*. 2012 Sep;33(8):e109-15.

- Gonshor A, Saroff S, Anderegg C, Joachim F, Charon J, Prasad H, Katta S. Histologic and Clinical Evaluation of a Bioactive Calcium Phosphosilicate Bone Graft Material in Postextraction Alveolar Sockets. *Int J Oral Imp and Clin Res*. 2011;2(2): 79-84.

- Hench L. The story of Bioglass. *J Mater Sci Mater Med*. 2006 Nov;17(11):967-78.

- Xynos ID, Edgar AJ, Buttery LD, Hench LL, Polak JM. Gene-expression profiling of human osteoblasts following treatment with the ionic products of Bioglass 45S5 dissolution. *J Biomed Mater Res*. 2001 May;55(2):151-7.

*We're here to help.*

**888.796.1923**

[sales@osteogenics.com](mailto:sales@osteogenics.com)

Contact us with questions or to place  
an order...or shop our products online!



TOLL-FREE	1.888.796.1923 US & Canada only
INTERNATIONAL	+1 806.796.1923
FAX	806.796.0059
EMAIL	<a href="mailto:sales@osteogenics.com">sales@osteogenics.com</a>
WEBSITE	<a href="http://www.osteogenics.com">www.osteogenics.com</a>
ADDRESS	Osteogenics Biomedical, Inc. 4620 71st Street   Building 78-79 Lubbock, TX 79424

*Revised 7.24 | CAT-PL*



**UNRIVALED**  
REGEN SOLUTIONS

---

*For more than 25 years, Osteogenics' mission has been to provide our customers with best-in-class, predictable, cutting-edge dental bone grafting products. With ridge augmentation, ridge preservation, sinus elevation, and suturing procedures in mind, our product portfolio has been able to expand and evolve to fit the needs of our loyal customers. Ultimately, developing superior regenerative products means providing*  
**a brighter future FOR OUR PATIENTS.**